

# Height Adjustable Kitchen Systems



## ABOUT US

GRANBERG



Six decades have passed since the joinery

*“Bröderna Granbergs snickeri”* built its first specially-adapted kitchen for the functionally impaired.

Today we view our work from a broader perspective. Our mission is to make everyday chores simpler and more comfortable for everyone. By developing, manufacturing and delivering innovative high-comfort solutions for kitchens and bathrooms, we have reached a world-leading position while still maintaining a down-to-earth approach and a genuine interest in our customer’s needs and wishes.



# CONTENTS

---

ABOUT GRANBERG	4
LIFTING SYSTEMS FOR WALL CABINETS	6
VERTI 830/831 - Vertical lifting system	8
InDIAGO 510 - Diagonal lifting system	14
DIAGO 504 - Diagonal lifting system fittings	20
LIFTING SYSTEMS FOR KITCHEN WORKTOPS	26
BASELIFT 6300 / 6310 - Straight worktop lift	28
BASELIFT Corner 6301 / 6311 - Corner worktop lift, 45° front, 90° wall	36
BASELIFT Corner 6302 / 6312 - Corner worktop lift, 45° front, 45° wall	44
BASELIFT Corner 6303 / 6313 - Corner worktop lift, 90° front, 90° wall	52
SIDELIFT 6400 - Straight worktop lift with motors on the sides	60
MANULIFT 6380 - Manually adjustable kitchen worktop	68
LIFTING SYSTEMS FOR KITCHEN ISLANDS	
CENTERLIFT 960 - Kitchen island with space for knees	76
CENTERLIFT 6490 - Kitchen island with cabinets and space for knees	82
ERGOSTEEL	90
Inset sinks	92
Sit-on sinks	94
Sink accessories	96
Mixer taps	98
OTHER	
Mini-cabinet on wheels	99
UNILIFT 870 - Kitchen appliance lift	100
BUTLER 720 - Electric wardrobe lift	102
BUTLER 722 - Electric wardrobe lift	104



**It all began back in 1870** in Ringarum when Otto Granberg made his first chairs. He sold the chairs at local markets. The business went well and Otto started manufacturing series of furniture at his joinery. Later, the factory was moved to Norrköping and the range was extended to include windows, doors and stairs.

After nearly thirty years, Otto's son Frans took over the company. He continued in his father's footsteps but also made furniture for schools and interior fittings and furnishings. Just over thirty years later, Frans handed over the company to his sons Nils, Bängt, Oscar and Erik. They continued to run the company in the same way as their father and grandfather.

Granbergs became renowned at an early stage for giving customers a lifetime guarantee on their goods. The quality of their products was high and if something broke nevertheless, the brothers made sure it was repaired or replaced. This is still the case today. Personal service and reliable products. Ninety years after Otto began making chairs, the company changed its profile and in 1960, Granbergs' modern era began. The company began to develop products for people with functional variations and is now a world-leading company in this sector.



**Ever since 1870**, when Otto Granberg started our company, quality has been an important part of our brand.

As a family business, we want to be proud of the products we create. Therefore, we only deliver quality products that we have worked with for many years and which we are confident we make well. In order for our customers to have even more confidence in our products, we always provide a two-year guarantee.



**For your safety**, we only work with CE-labelled lifting systems that have undergone risk analyses and tests. Our lifting systems are based on thoroughly tested technology and have built-in safety systems that stop all moving parts if anything gets in the way.





**SINCE 1870**

**GRANBERG**

# Lifting systems for wall cabinets

## Product overview

Our lifting systems for wall cabinets are designed to be mounted in existing kitchens or supplemented with cabinets from any kitchen supplier. Choose between a vertical or diagonal lifting system that is mounted inside the cabinet or a diagonal lift that lowers the entire cabinet.

The lifting systems are based on proven technology and have built-in safety systems that stop the moving parts if something gets in the way.



## VERTI 830 / 831

Page 8

- Lowers the shelf unit vertically down to the top board
- When lowered, there is free space on the work top in front of the shelves
- Installed in a new or existing cabinet from which the bottom has been removed



## InDIAGO 510

Page 14

- Lowers the cabinet unit diagonally downwards and forwards to the front edge of the top board
- Easy to reach the contents since the unit moves forward as it is lowered
- When lowered, the cabinet unit passes in front of the mixer tap
- Easily mounted in new or existing cabinets without the bottom having to be removed. Strip lighting and light ramps are not affected



## DIAGO 504

Page 20

- Lowers one or more cabinets diagonally downwards and forwards to the front edge of the top board
- Easy to reach the contents since the cabinet comes forward when lowered
- Takes up no space in the cabinet (mounted behind the cabinet)



# VERTI 830/831

Vertical lifting system for wall cabinets

VERTI is an electric height-adjustable lifting system that lowers the cabinet shelves quickly and silently down to the worktop. The contents of the cabinet are accessible without having to open the doors. When lowered, there is free space on the worktop in front of the shelves. The movement can be stopped at any height.

The lift takes up little space and can easily be mounted in existing or new cabinets without them having to protrude further from the wall.

Fits wall cabinets that are 70 cm high or taller. The lift is available in two different depths and in a wide range of widths to fit cabinets that are 40-100 cm wide.

The lift is equipped with a reliable safety system that guarantees safe operation without any risk of pinching. Lighting and a light ramp can be mounted on the underside of the lift.

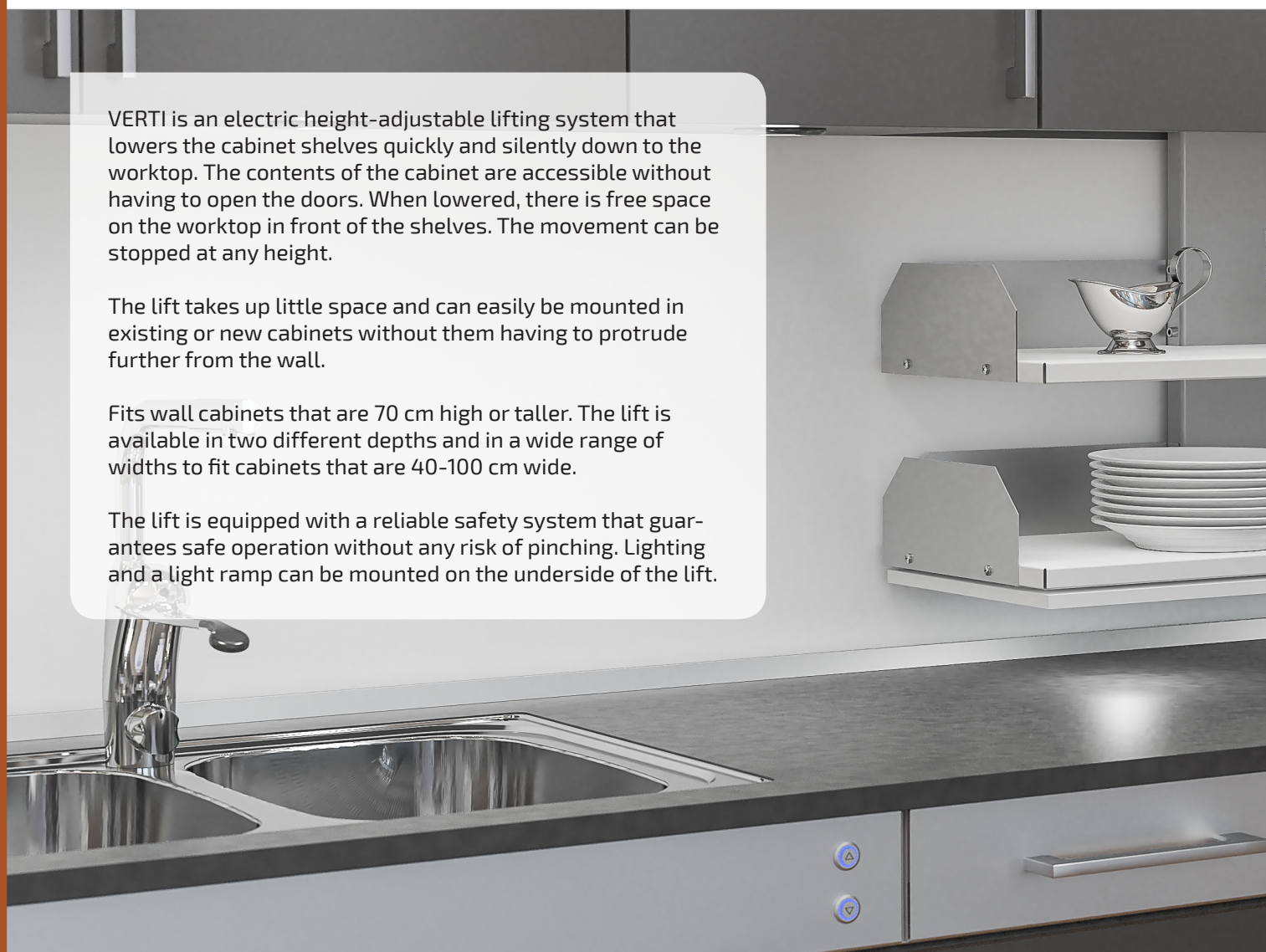

The contents are easy to reach when the shelves are lowered. Can be positioned over a worktop with an open front which provides space for knees.





VERTI is suitable for use over a work surface since after being lowered, there is still space at the front of the worktop.



VERTI is mounted inside the wall cabinet and is fully concealed when in the raised position.



### Functions and advantages

- Lowers the shelf unit vertically down to the top board
- When lowered, there is free space on the worktop in front of the shelves
- Installed in a new or existing cabinet from which the bottom has been removed
- Safety plate stops the lowering if it comes in contact with any object on the underlying work surface
- Fits cabinets with width 40-100 cm

### Standard equipment

- Control button
- Safety switch under the bottom shelf
- Motor cover with built-in safety switch

### Recommended additional options

- Lighting

### Useful information

- Leaves a 22-mm gap from wall (space for tiling)
- Model 830 fits cabinets with an inner depth of 265-314 mm. The shelf depth is 242 mm
- Model 831 fits cabinets with an inner depth of 315 mm or more. The shelf depth is 286 mm
- For cabinets taller than 700 mm, a fixed shelf is mounted above the lift
- Electronics and motor system "Plug and Play"

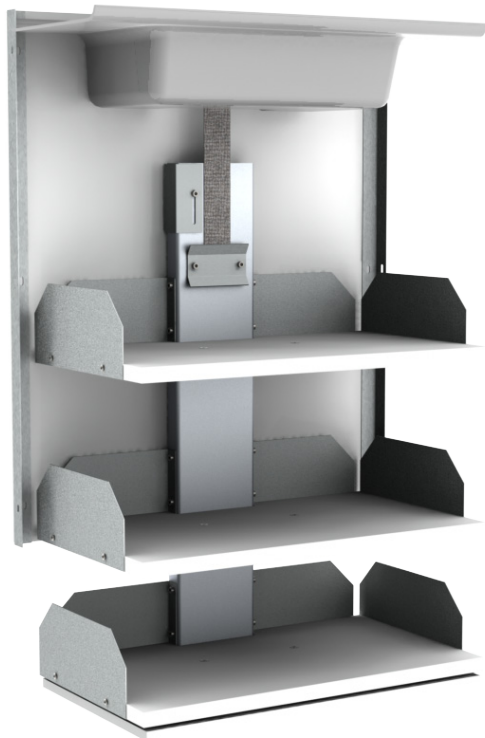

### Specifications

<b>Lift model</b>	Vertical lifting system for wall cabinets
<b>Height adjustment</b>	Motorised, steplessly adjustable 470 mm downwards
<b>Speed</b>	47 mm/sec.
<b>Manoeuvring</b>	Wired button or remote control
<b>Safety</b>	Safety plate under the bottom shelf. If anything touches the plate, the lift stops. The plastic cover in the upper part of the cabinet acts as a safety breaker upwards. If the plastic cover is touched, the lift stops.
<b>Electricity connection</b>	Plug for 230 V, max 0.5 A
<b>Lifting power</b>	40 kg
<b>IP Class</b>	IP30
<b>Height</b>	680 mm
<b>Fits cabinets with width</b>	400-1000 mm
<b>Fits cabinets with height</b>	700 mm or higher (for heights over 700 mm, a fixed shelf is mounted above the lift)
<b>Fits cabinets with inner depth</b>	VERTI 830: 265 - 314 mm VERTI 831: From 315 mm
<b>Fits cabinet frames with side thickness</b>	16-20 mm
<b>Material specifications</b>	Back plate (thickness 16 mm) and shelves (thickness 19 mm) in white melamine. Safety plate of white-painted MDF. Powder-lacquered sheet metal parts (Alu-grey RAL 9006), motor cover in Alu-grey plastic. Aluminium sliding rail.
<b>Warranty</b>	2 year CE

### Measurement data

(mm)

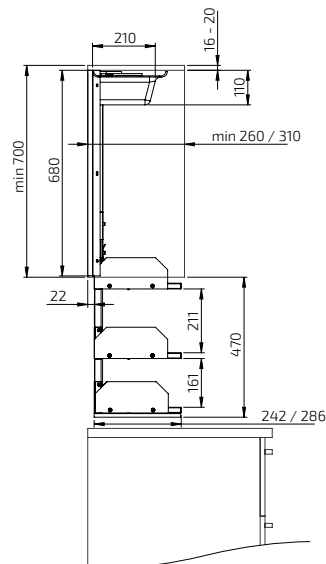
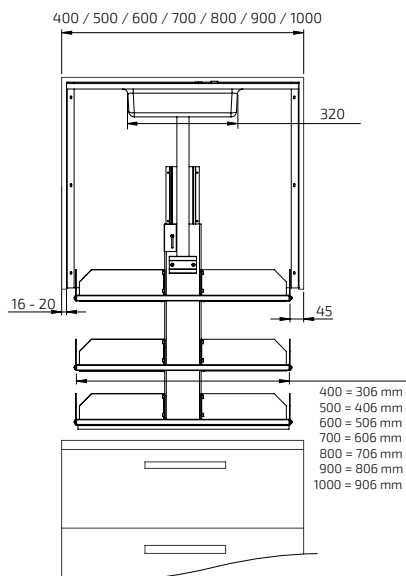

**VERTI 830/831, height 70.0 cm**  
- Fixed button

**Delivery includes:**  
Lifting unit  
Transformer  
Control button in ALU-design

**Measurement data:**  
Cabinet width: 40.0-100.0 cm  
Cabinet height: 70.0 cm or higher\*  
Cabinet frame: 1.6-2.0 cm

**VERTI 830: 26.5 cm deep:**  
Fits cabinets with inner depth: 26.5 - 31.4 cm

**VERTI 831: 31.0 cm deep:**  
Fits cabinets with inner depth: From 31.5 cm



**VERTI 830 / 831, height 70.0 cm**  
- Radio control, hand control

**Delivery includes:**  
Lifting unit  
Transformer  
Radio control, hand control

**Measurement data:**  
Cabinet width: 40.0-100.0 cm  
Cabinet height: 70.0 cm or higher\*  
Cabinet frame: 1.6-2.0 cm

**VERTI 830: 26.5 cm deep:**  
Fits cabinets with inner depth: 26.5 - 31.4 cm

**VERTI 831: 31.0 cm deep:**  
Fits cabinets with inner depth: From 31.5 cm



	Cabinet width (cm)	Shelf width (cm)	Depth (cm)	Art. no.
Width of lift 36.0 cm	40.0	31.5	26.5	830-040-01
Width of lift 46.0 cm	50.0	41.5	26.5	830-050-01
Width of lift 56.0 cm	60.0	51.5	26.5	830-060-01
Width of lift 66.0 cm	70.0	61.5	26.5	830-070-01
Width of lift 76.0 cm	80.0	71.5	26.5	830-080-01
Width of lift 86.0 cm	90.0	81.5	26.5	830-090-01
Width of lift 96.0 cm	100.0	91.5	26.5	830-100-01
Width of lift 36.0 cm	40.0	31.5	31.0	831-040-01
Width of lift 46.0 cm	50.0	41.5	31.0	831-050-01
Width of lift 56.0 cm	60.0	51.5	31.0	831-060-01
Width of lift 66.0 cm	70.0	61.5	31.0	831-070-01
Width of lift 76.0 cm	80.0	71.5	31.0	831-080-01
Width of lift 86.0 cm	90.0	81.5	31.0	831-090-01
Width of lift 96.0 cm	100.0	91.5	31.0	831-100-01

	Cabinet width (cm)	Shelf width (cm)	Depth (cm)	Art. no.
Width of lift 36.0 cm	40.0	31.5	26.5	830-040-06
Width of lift 46.0 cm	50.0	41.5	26.5	830-060-06
Width of lift 56.0 cm	60.0	51.5	26.5	830-060-06
Width of lift 66.0 cm	70.0	61.5	26.5	830-070-06
Width of lift 76.0 cm	80.0	71.5	26.5	830-080-06
Width of lift 86.0 cm	90.0	81.5	26.5	830-090-06
Width of lift 96.0 cm	100.0	91.5	26.5	830-100-06
Width of lift 36.0 cm	40.0	31.5	31.0	831-040-06
Width of lift 46.0 cm	50.0	41.5	31.0	831-060-06
Width of lift 56.0 cm	60.0	51.5	31.0	831-060-06
Width of lift 66.0 cm	70.0	61.5	31.0	831-070-06
Width of lift 76.0 cm	80.0	71.5	31.0	831-080-06
Width of lift 86.0 cm	90.0	81.5	31.0	831-090-06
Width of lift 96.0 cm	100.0	91.5	31.0	831-100-06

\* For cabinets taller than 70.0 cm, a fixed shelf is placed in the upper part of the cabinet.



**VERTI 830 - 26.5 cm depth**  
Fits cabinets with depth: 26.5-31.4 cm  
Fits cabinets with height: 70.0 cm or higher\*

Width of lift 36.0 cm	830-040
Width of lift 46.0 cm	830-050
Width of lift 56.0 cm	830-060
Width of lift 66.0 cm	830-070
Width of lift 76.0 cm	830-080
Width of lift 86.0 cm	830-090
Width of lift 96.0 cm	830-100

**VERTI 831 - 31.0 cm depth**  
Fits cabinets with depth: From 31.5 cm  
Fits cabinets with height: 70.0 cm or higher\*

Width of lift 36.0 cm	831-040
Width of lift 46.0 cm	831-050
Width of lift 56.0 cm	831-060
Width of lift 66.0 cm	831-070
Width of lift 76.0 cm	831-080
Width of lift 86.0 cm	831-090
Width of lift 96.0 cm	831-100



**Control button, Mini**  
Wired, for recessed mounting  
Diameter: 20 mm

61315



**Control button in ALU-design**  
Wired, for recessed mounting  
Dimensions: 82 x 82 x 17 mm

61310



**Radio controlled - Fixed mounting**  
Control button with built-in radio control of a lift.

The button is recess fitted in the front of the worktop lift. (Requires no wiring).

The delivery includes receiver, battery and control button.

Dimensions: 82 x 82 x 17 mm (52 mm total depth)

61371

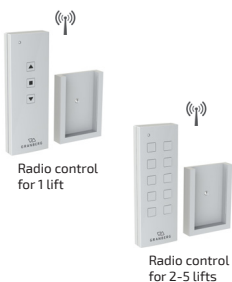

**Radio control - Hand control**  
Dimensions: 38 x 110 x 10 mm

For one lift	61385
For two lifts	61387
For three lifts	61388
For four lifts	61389
For five lifts	61390



**Extension frame for aluminium button**  
Enables surface mounting of aluminium buttons.  
Colour: White  
Dimensions: 82 x 82 x 52 mm

61355

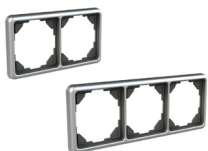

**Multi-compartment frame, ALU-design**  
Collects power socket, power switch or control buttons in a multi-compartment frame

Two-compartment frame: 153 x 82 x 9 mm	61352
Three-compartment frame: 225 x 82 x 9 mm	61353

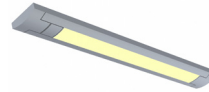

**LED light ramp**  
Mounted under the safety plate. The lamp is energy-efficient and does not get hot. On/Off switch is on the lamp. Connects to a 230 V socket via the supplied transformer.

Colour temperature: Warm white 3000K, 6.0 W  
Dimensions: 340 x 13 x 40 mm

**NB! Does not fit VERTI 40.0 cm**

For fixed cabinets 61931

For movable cabinets (with spiral cable) 61932



**LED Spotlights**  
Mounted under the safety plate. The lights are energy-efficient and do not get hot. Connects to a 230 V socket via the supplied transformer. 3.0 W  
Ø 70 mm, H=11 mm

For fixed cabinets 61941

For movable cabinets (with spiral cable) 61938



**Cable connection package Lighting**  
Set with spiral cable and pull-relief for connection of own lighting on movable cabinet.

61930

\* For cabinets taller than 70.0 cm, a fixed shelf is placed in the upper part of the cabinet.

# InDIAGO 510

Diagonal lifting system for wall cabinets

InDIAGO is a motorised lifting system that is lowered in a curved movement to the front of the work surface. The movement can be stopped at any height.

The lift does not make the cabinet protrude further from the wall and it does not take up much space in the cabinet. It is easily mounted in existing or new cabinets without the bottom of the cabinet having to be removed. Strip lighting and light ramps are not affected by the lift since the bottom of the cabinet is left intact.

The system also includes a function that automatically opens the doors when the unit is lowered. When the unit goes back into the cabinet, it slows down at the end so the doors are closed gently. The ingenious design also makes it possible to open the doors as usual when the unit is in the raised position.

The cabinet unit is available in two heights that fit 70 cm or 85 cm high cabinets. The lift is available in two different depths and in a wide range of widths to fit cabinets that are 50-100 cm wide.

The lift can be integrated in kitchens from any kitchen manufacturer.

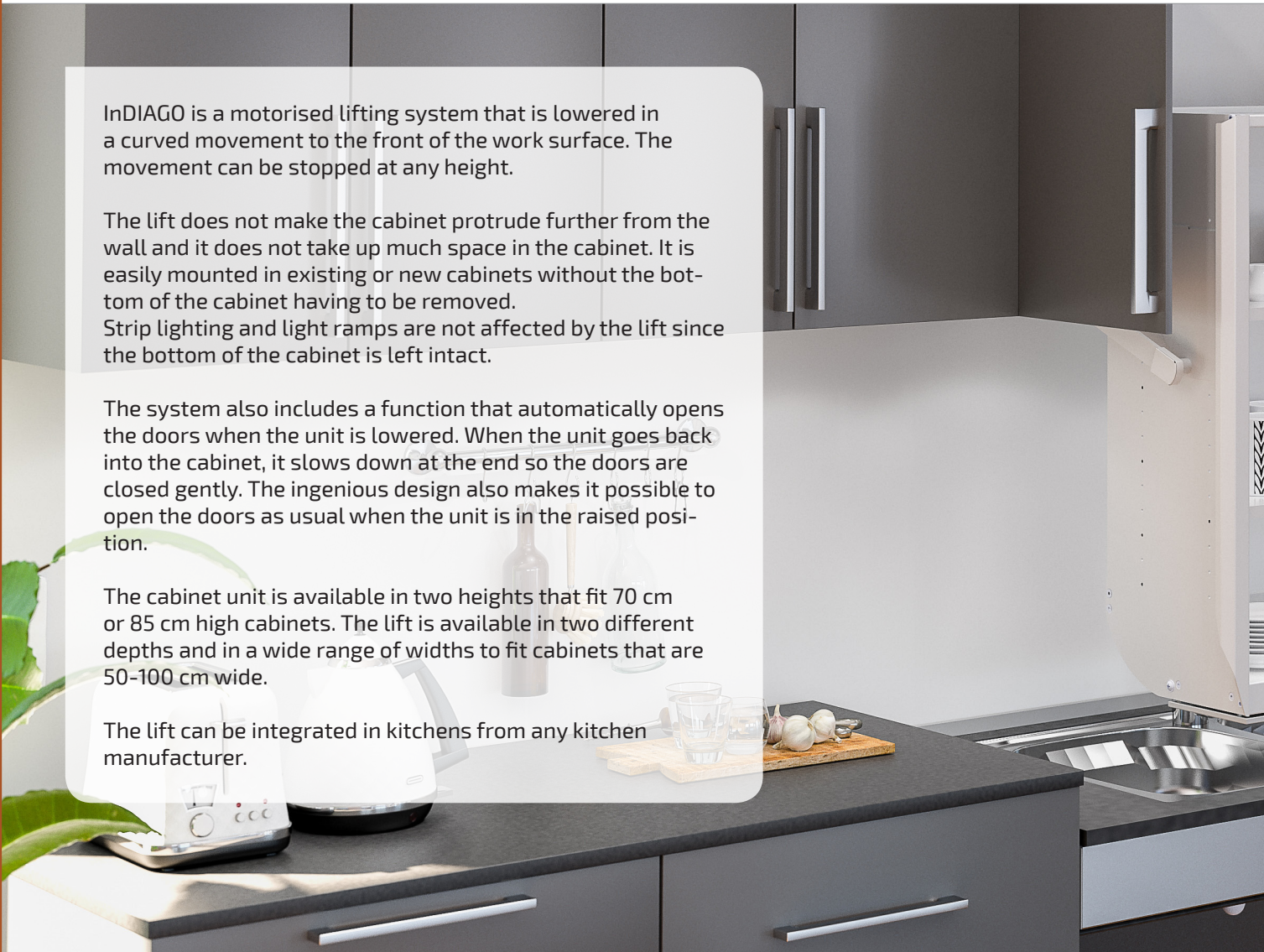

It is easy to reach the contents since the unit comes forward when lowered. The mechanics and motors are barely visible when the frame is lowered.



There is plenty of room for the mixer tap and other objects on the worktop when the frame is in the lowered position.



The mechanics and motors are optimally positioned so as to take up as little space as possible inside the cabinet.



### Functions and advantages

- Lowers the cabinet unit diagonally downwards and forwards to the front of the top board
- Easy to reach the contents since the unit moves forward as it is lowered
- When lowered, the cabinet unit passes in front of the mixer tap
- Easily mounted in new or existing cabinets without the bottom having to be removed. Strip lighting and light ramps are not affected
- Motor-driven automation that opens and closes the doors
- The lifting units are easily mounted in the cabinet. The lift is screwed to the inside of the cabinet
- The cabinet unit is delivered ready-mounted. Available in widths 50-100 cm
- The mechanics take up minimal space in the cabinet. Plates with a diameter of up to 29 cm can fit into the unit

### Standard equipment

- Control button
- Safety switch under the cabinet unit
- Motor-driven automation that opens and closes the doors

### Recommended additional options

- Lighting (mounted under the cabinet)

### Useful information

- Motorised, steplessly adjustable 540 mm downwards, 373 mm outwards
- Model 510A fits cabinets with an inner depth of 260-309 mm. The shelf depth is 230 mm
- Model 510B fits inside cabinets with a depth of minimum 310 mm. The depth of the shelf is 280 mm
- Available in two heights that fit a cabinet height of 700 mm or 850 mm (or higher)
- Electronics and motor system "Plug and Play"





### Specifications

<b>Lift model</b>	Diagonal lifting system for wall cabinets
<b>Height adjustment</b>	Motorised, steplessly adjustable 540 mm downwards, 373 mm outwards
<b>Speed</b>	23 mm/sec.
<b>Manoeuvring</b>	Wired button or radio control
<b>Automatic doors</b>	Motor-driven automation that opens and closes the doors
<b>Safety</b>	Safety plate under the lifting system. If anything touches the plate, the lift stops.
<b>Electricity connection</b>	Plug for 230 V, Max 2.0 A
<b>Lifting power</b>	40 kg
<b>IP Class</b>	IP30
<b>Height</b>	660 / 810 mm
<b>Fits cabinets with width</b>	500 - 1000 mm
<b>Fits cabinets with height</b>	700 cm or higher
<b>Fits cabinets with inner depth</b>	InDIAGO 510KA / 510SA: 260 - 309 mm, InDIAGO 510KB / 510SB: From 310 mm
<b>Fits cabinet frames with side thickness</b>	16-20 mm
<b>Material specifications</b>	Cabinet lifting system in powder-lacquered aluminium (white). Back and ceiling of HDF. Shelves of white melamine (16 mm). Powder-lacquered sheet metal parts (white)
<b>Warranty</b>	2 year
	CE

### Measurement data

(mm)

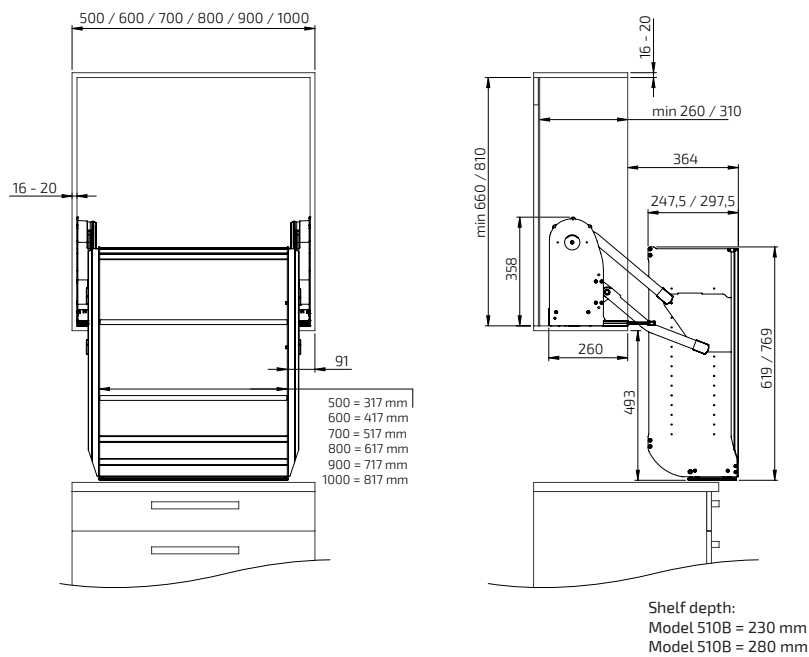

**InDIAGO 510, height 70.0 cm**  
- Fixed button

**Delivery includes:**  
Lifting unit  
Control unit and transformer  
Control button in ALU-design  
Automatic doors

**Measurement data:**  
Cabinet width: 50.0-100.0 cm  
Cabinet height: 70.0-84.0 cm  
Fits cabinet frame: 1.6-2.0 cm



**InDIAGO 510KA: 26.0 cm deep:**  
Fits cabinets with inner depth: 26.0 - 30.9 cm

**InDIAGO 510KB: 31.0 cm deep:**  
Fits cabinets with inner depth: From 31.0 cm

**InDIAGO 510, height 85.0 cm**  
- Fixed button

**Delivery includes:**  
Lifting unit  
Control unit and transformer  
Control button in ALU-design  
Automatic doors

**Measurement data:**  
Cabinet width: 50.0-100.0 cm  
Cabinet height: 85.0 cm or higher  
Fits cabinet frame: 1.6-2.0 cm



**InDIAGO 510SA: 26.0 cm deep:**  
Fits cabinets with inner depth: 26.0 - 30.9 cm

**InDIAGO 510SB: 31.0 cm deep:**  
Fits cabinets with inner depth: From 31.0 cm

	Cabinet width (cm)	Shelf width (cm)	Depth (cm)	Art. no.
Width of lift 46.0 cm	50.0	33.0	26.0	510KA-050-01
Width of lift 56.0 cm	60.0	43.0	26.0	510KA-060-01
Width of lift 66.0 cm	70.0	53.0	26.0	510KA-070-01
Width of lift 76.0 cm	80.0	63.0	26.0	510KA-080-01
Width of lift 86.0 cm	90.0	73.0	26.0	510KA-090-01
Width of lift 96.0 cm	100.0	83.0	26.0	510KA-100-01
Width of lift 46.0 cm	50.0	33.0	31.0	510KB-050-01
Width of lift 56.0 cm	60.0	43.0	31.0	510KB-060-01
Width of lift 66.0 cm	70.0	53.0	31.0	510KB-070-01
Width of lift 76.0 cm	80.0	63.0	31.0	510KB-080-01
Width of lift 86.0 cm	90.0	73.0	31.0	510KB-090-01
Width of lift 96.0 cm	100.0	83.0	31.0	510KB-100-01

	Cabinet width (cm)	Shelf width (cm)	Depth (cm)	Art. no.
Width of lift 46.0 cm	50.0	33.0	26.0	510SA-050-01
Width of lift 56.0 cm	60.0	43.0	26.0	510SA-060-01
Width of lift 66.0 cm	70.0	53.0	26.0	510SA-070-01
Width of lift 76.0 cm	80.0	63.0	26.0	510SA-080-01
Width of lift 86.0 cm	90.0	73.0	26.0	510SA-090-01
Width of lift 96.0 cm	100.0	83.0	26.0	510SA-100-01
Width of lift 46.0 cm	50.0	33.0	31.0	510SB-050-01
Width of lift 56.0 cm	60.0	43.0	31.0	510SB-060-01
Width of lift 66.0 cm	70.0	53.0	31.0	510SB-070-01
Width of lift 76.0 cm	80.0	63.0	31.0	510SB-080-01
Width of lift 86.0 cm	90.0	73.0	31.0	510SB-090-01
Width of lift 96.0 cm	100.0	83.0	31.0	510SB-100-01

**InDIAGO 510, height 70.0 cm**  
- Radio control, hand control

**Delivery includes:**  
Lifting unit  
Control unit and transformer  
Radio control, hand control  
Automatic doors

**Measurement data:**  
Cabinet width: 50.0-100.0 cm  
Cabinet height: 70.0-84.0 cm  
Fits cabinet frame: 1.6-2.0 cm



**InDIAGO 510KA: 26.0 cm deep:**  
Fits cabinets with inner depth: 26.0 - 30.9 cm

**InDIAGO 510KB: 31.0 cm deep:**  
Fits cabinets with inner depth: From 31.0 cm

**InDIAGO 510, height 85.0 cm**  
- Radio control, hand control

**Delivery incl:** Lifting unit  
Control unit and transformer  
Radio control, hand control  
Automatic doors

**Measurement data:**  
Cabinet width: 50.0-100.0 cm  
Cabinet height: 85.0 cm or higher  
Fits cabinet frame: 1.6-2.0 cm



**InDIAGO 510SA: 26.0 cm deep:**  
Fits cabinets with inner depth: 26.0 - 30.9 cm

**InDIAGO 510SB: 31.0 cm deep:**  
Fits cabinets with inner depth: From 31.0 cm

	Cabinet width (cm)	Shelf width (cm)	Depth (cm)	Art. no.
Width of lift 46.0 cm	50.0	33.0	26.0	510KA-050-06
Width of lift 56.0 cm	60.0	43.0	26.0	510KA-060-06
Width of lift 66.0 cm	70.0	53.0	26.0	510KA-070-06
Width of lift 76.0 cm	80.0	63.0	26.0	510KA-080-06
Width of lift 86.0 cm	90.0	73.0	26.0	510KA-090-06
Width of lift 96.0 cm	100.0	83.0	26.0	510KA-100-06
Width of lift 46.0 cm	50.0	33.0	31.0	510KB-050-06
Width of lift 56.0 cm	60.0	43.0	31.0	510KB-060-06
Width of lift 66.0 cm	70.0	53.0	31.0	510KB-070-06
Width of lift 76.0 cm	80.0	63.0	31.0	510KB-080-06
Width of lift 86.0 cm	90.0	73.0	31.0	510KB-090-06
Width of lift 96.0 cm	100.0	83.0	31.0	510KB-100-06

	Cabinet width (cm)	Shelf width (cm)	Depth (cm)	Art. no.
Width of lift 46.0 cm	50.0	33.0	26.0	510SA-050-06
Width of lift 56.0 cm	60.0	43.0	26.0	510SA-060-06
Width of lift 66.0 cm	70.0	53.0	26.0	510SA-070-06
Width of lift 76.0 cm	80.0	63.0	26.0	510SA-080-06
Width of lift 86.0 cm	90.0	73.0	26.0	510SA-090-06
Width of lift 96.0 cm	100.0	83.0	26.0	510SA-100-06
Width of lift 46.0 cm	50.0	33.0	31.0	510SB-050-06
Width of lift 56.0 cm	60.0	43.0	31.0	510SB-060-06
Width of lift 66.0 cm	70.0	53.0	31.0	510SB-070-06
Width of lift 76.0 cm	80.0	63.0	31.0	510SB-080-06
Width of lift 86.0 cm	90.0	73.0	31.0	510SB-090-06
Width of lift 96.0 cm	100.0	83.0	31.0	510SB-100-06



**InDIAGO 510KA - 26.0 cm depth**  
Fits cabinets with depth: 26.0-30.9 cm  
Fits cabinets with height: 70.0-84.0 cm

Width of lift 46.0 cm	510KA-050
Width of lift 56.0 cm	510KA-060
Width of lift 66.0 cm	510KA-070
Width of lift 76.0 cm	510KA-080
Width of lift 86.0 cm	510KA-090
Width of lift 96.0 cm	510KA-100

**InDIAGO 510KB - 31.0 cm depth**  
Fits cabinets with depth: From 31.0 cm  
Fits cabinets with height: 70.0-84.0 cm

Width of lift 46.0 cm	510KB-050
Width of lift 56.0 cm	510KB-060
Width of lift 66.0 cm	510KB-070
Width of lift 76.0 cm	510KB-080
Width of lift 86.0 cm	510KB-090
Width of lift 96.0 cm	510KB-100



**InDIAGO 510SA - 26.0 cm depth**  
Fits cabinets with depth: 26.0-30.9 cm  
Fits cabinets with height: 85.0 cm or higher

Width of lift 46.0 cm	510SA-050
Width of lift 56.0 cm	510SA-060
Width of lift 66.0 cm	510SA-070
Width of lift 76.0 cm	510SA-080
Width of lift 86.0 cm	510SA-090
Width of lift 96.0 cm	510SA-100

**InDIAGO 510SB - 31.0 cm depth**  
Fits cabinets with depth: From 31.0 cm  
Fits cabinets with height: 85.0 cm or higher

Width of lift 46.0 cm	510SB-050
Width of lift 56.0 cm	510SB-060
Width of lift 66.0 cm	510SB-070
Width of lift 76.0 cm	510SB-080
Width of lift 86.0 cm	510SB-090
Width of lift 96.0 cm	510SB-100



**Control button, Mini**  
Wired, for recessed mounting  
Diameter: 20 mm

61316



**Control button in ALU-design**  
Wired, for recessed mounting  
Dimensions: 82 x 82 x 17 mm

61210



**Radio controlled - Fixed mounting**  
Control button with built-in radio control of a lift.

The button is recessed mounted in the front of the worktop lift. (Requires no wiring).

The delivery includes receiver, battery and control button.

Dimensions: 82 x 82 x 17 mm (52 mm total depth)

61370



Radio control for 1 lift

Radio control for 2-5 lifts

**Radio control - Hand control**  
Dimensions: 38 x 110 x 10 mm

For one lift 61395

For two lifts 61396

For three lifts 61397

For four lifts 61398

For five lifts 61399



**Extension frame for aluminium button**  
Enables surface mounting of aluminium buttons.  
Colour: White  
Dimensions: 82 x 82 x 52 mm

61355



**Multi-compartment frame, ALU-design**  
Collects power socket, power switch or control buttons in a multi-compartment frame

Two-compartment frame: 153 x 82 x 9 mm 61352

Three-compartment frame: 225 x 82 x 9 mm 61353

# DIAGO 504

Diagonal lifting system for wall cabinets

DIAGO 504 is an electrical height-adjustable lifting system used for the mounting of new or existing wall cabinets. The lift is a diagonal lift that lowers the cabinet in a curved motion downwards and forwards to the front of the work surface. The movement can be stopped at any height.

The lift is available in two widths that fit cabinets from 60.0 cm to 180 cm. The upper cabinet beam is adjustable to fit cabinet heights 70-110 cm. The cabinets can be fine-tuned in all planes (X, Y, Z) to fit the surrounding cabinets exactly. The lift protrudes 11 cm from the wall which must be taken into account when mounting the surrounding cabinets.

The lift is equipped with a reliable safety system that guarantees safe operation without any risk of pinching. Lighting and a light ramp can be mounted on the safety plates. The lift can be integrated with kitchens from any kitchen manufacturer.



DIAGO 504 brings the cabinets forward as they are lowered. This makes it easy to reach the cabinets even from a seated position.



Several cabinets can be mounted on the lift. (Max 180 cm). A microwave oven can also be lowered.



### Functions and advantages

- Lowers one or more cabinets diagonally downwards and forwards to the front of the worktop
- Takes up no space in the cabinet (mounted behind the cabinet)
- Easy to reach the contents since the cabinet comes forward when lowered
- Adjustable depth in all four corners provides the possibility to compensate for inclining wall
- Safety plate stops the lowering if it comes in contact with any object on the underlying work surface. Mounted under the cabinets
- Fits cabinets with height 70-110 cm
- Maximum cabinet width 180 cm

### Standard equipment

- Control button
- Safety switch in the form of safety plates that are screwed onto the underside of the cabinet

### Recommended additional options

- Lighting
- Screen

### Useful information

- Steplessly adjustable 435 mm downwards, 227 mm outwards
- Fits cabinets with height 700-1100 mm
- Fits cabinets with depth 260-400 mm
- When the lift is in the raised position, the cabinet protrudes 110 mm further. To conceal that, adjoining cabinets must be positioned so they protrude the same distance.
- There must be a gap for movement of 5-8 mm to the next cabinet/wall.

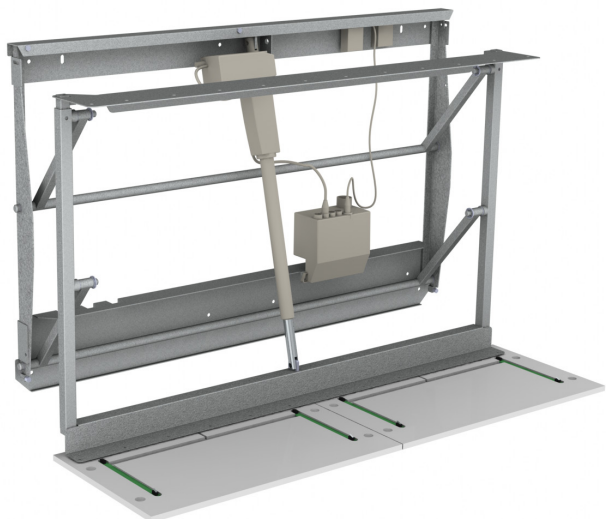

### Specifications

<b>Lift model</b>	Diagonal lifting system for wall cabinets
<b>Height adjustment</b>	Motorised, steplessly adjustable 435 mm downwards, 227 mm outwards
<b>Speed</b>	17 mm / sec.
<b>Manoeuvring</b>	Wired button or radio control
<b>Safety</b>	Safety plate mounted under the cabinet. If anything touches the plate, the lift stops.
<b>Electricity connection</b>	Plug for 230 V, Max 1.5 A
<b>Lifting power</b>	150 kg
<b>IP Class</b>	IPX4
<b>Frame height</b>	720 mm
<b>Frame width</b>	550 (cabinet width 600-1100 mm) 1150 mm (cabinet width 1200-1800 mm)
<b>Gap to adjoining cabinet/wall</b>	5 mm
<b>Protrudes from wall</b>	110 mm
<b>Fits cabinets width</b>	600 - 1800 mm
<b>Fits cabinets height</b>	700 - 1100 mm
<b>Fits cabinets depth</b>	260 - 400 mm
<b>Material specifications</b>	Powder-lacquered steel frame (Alu-grey RAL 9006), white-painted safety plates in 12 mm MDF, depth 350 mm
<b>Warranty</b>	2 year
	CE

### Measurement data

(mm)

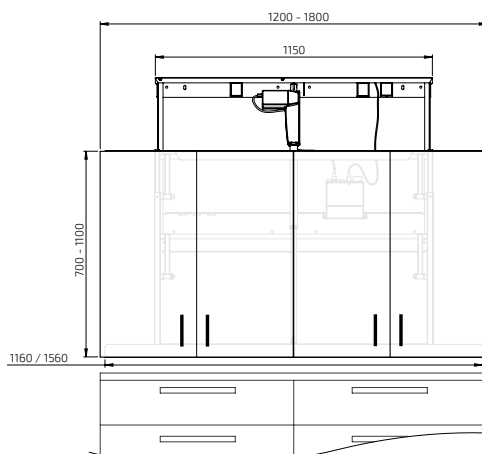
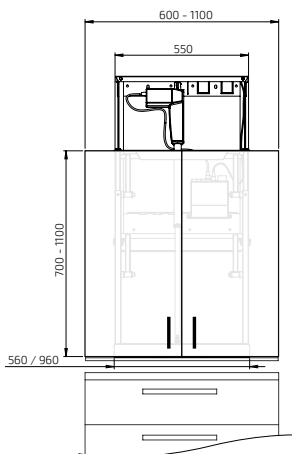
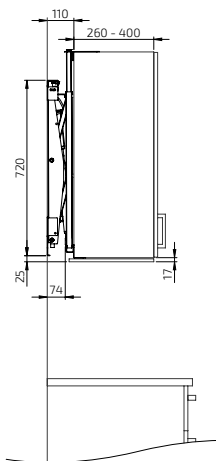
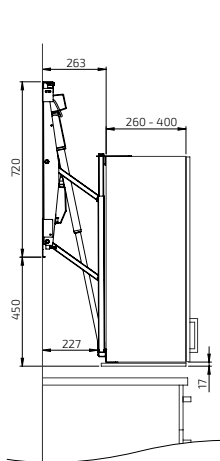

## DIAGO 504

### Delivery includes:

Lifting unit 55 cm wide  
Adjustable cabinet beams  
Safety plates

### Measurement data:

Cabinet width: 60.0-110.0 cm  
Cabinet height: 70.0-110.0 cm  
Cabinet depth: 26.0-40.0 cm



	Cabinet width (cm)	Planning width* (cm)	Cabinet beams, width (cm)	Art. no.
Safety plate (60.0 cm)	60.0	61.0	56.0	504-060
Safety plate (70.0 cm)	70.0	71.0	56.0	504-070
Safety plate (80.0 cm)	80.0	81.0	56.0	504-080
Safety plates (45.0 + 45.0 cm)	90.0	91.0	56.0	504-090
Safety plates (50.0 + 50.0 cm)	100.0	101.0	96.0	504-100
Safety plates (60.0 + 50.0 cm)	110.0	111.0	96.0	504-110

## DIAGO 504

### Delivery includes:

Lifting unit 115 cm wide  
Adjustable cabinet beams  
Safety plates

### Measurement data:

Cabinet width: 120.0-180.0 cm  
Cabinet height: 70.0-110.0 cm  
Cabinet depth: 26.0-40.0 cm

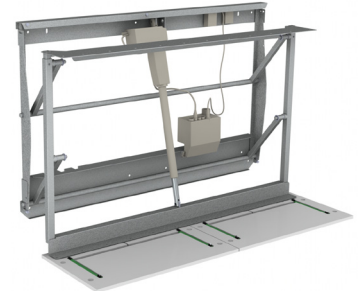

	Cabinet width (cm)	Planning width* (cm)	Cabinet beams, width (cm)	Art. no.
Safety plates (60.0 + 60.0 cm)	120.0	121.0	116.0	504-120
Safety plates (60.0 + 70.0 cm)	130.0	131.0	116.0	504-130
Safety plates (60.0 + 80.0 cm)	140.0	141.0	116.0	504-140
Safety plates (70.0 + 80.0 cm)	150.0	151.0	116.0	504-150
Safety plates (80.0 + 80.0 cm)	160.0	161.0	156.0	504-160
Safety plates (60.0 + 60.0 cm)	170.0	171.0	156.0	504-170
Safety plates (60.0+60.0+60.0 cm)	180.0	181.0	156.0	504-180

## DIAGO 504 - Fixed button

### Delivery includes:

Lifting unit 55 cm wide  
Adjustable cabinet beams  
Safety plates  
Control button in ALU-design

### Measurement data:

Cabinet width: 60.0-110.0 cm  
Cabinet height: 70.0-110.0 cm  
Cabinet depth: 26.0-40.0 cm



	Cabinet width (cm)	Planning width* (cm)	Cabinet beams, width (cm)	Art. no.
Safety plate (60.0 cm)	60.0	61.0	56.0	504-060-01
Safety plate (70.0 cm)	70.0	71.0	56.0	504-070-01
Safety plate (80.0 cm)	80.0	81.0	56.0	504-080-01
Safety plates (45.0 + 45.0 cm)	90.0	91.0	56.0	504-090-01
Safety plates (50.0 + 50.0 cm)	100.0	101.0	96.0	504-100-01
Safety plates (60.0 + 50.0 cm)	110.0	111.0	96.0	504-110-01

## DIAGO 504-Fixed button

### Delivery includes:

Lifting unit 115 cm wide  
Adjustable cabinet beams  
Safety plates  
Control button in ALU-design

### Measurement data:

Cabinet width: 120.0-180.0 cm  
Cabinet height: 70.0-110.0 cm  
Cabinet depth: 26.0-40.0 cm

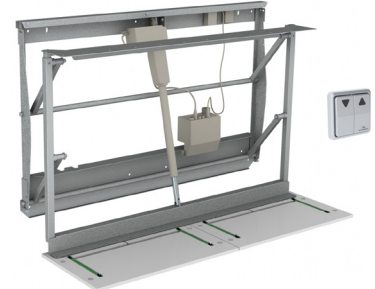

	Cabinet width (cm)	Planning width* (cm)	Cabinet beams, width (cm)	Art. no.
Safety plates (60.0 + 60.0 cm)	120.0	121.0	116.0	504-120-01
Safety plates (60.0 + 70.0 cm)	130.0	131.0	116.0	504-130-01
Safety plates (60.0 + 80.0 cm)	140.0	141.0	116.0	504-140-01
Safety plates (70.0 + 80.0 cm)	150.0	151.0	116.0	504-150-01
Safety plates (80.0 + 80.0 cm)	160.0	161.0	156.0	504-160-01
Safety plates (60.0 + 60.0 cm)	170.0	171.0	156.0	504-170-01
Safety plates (60.0+60.0+60.0 cm)	180.0	181.0	156.0	504-180-01

## DIAGO 504

### - Radio control, hand control

### Delivery includes:

Lifting unit 55 cm wide  
Adjustable cabinet beams  
Safety plates  
Radio control, hand control

### Measurement data:

Cabinet width: 60.0-110.0 cm  
Cabinet height: 70.0-110.0 cm  
Cabinet depth: 26.0-40.0 cm



	Cabinet width (cm)	Planning width* (cm)	Cabinet beams, width (cm)	Art. no.
Safety plate (60.0 cm)	60.0	61.0	56.0	504-060-06
Safety plate (70.0 cm)	70.0	71.0	56.0	504-070-06
Safety plate (80.0 cm)	80.0	81.0	56.0	504-080-06
Safety plates (45.0 + 45.0 cm)	90.0	91.0	56.0	504-090-06
Safety plates (50.0 + 50.0 cm)	100.0	101.0	96.0	504-100-06
Safety plates (60.0 + 50.0 cm)	110.0	111.0	96.0	504-110-06

## DIAGO 504

### - Radio control, hand control

### Delivery includes:

Lifting unit 115 cm wide  
Adjustable cabinet beams  
Safety plates  
Radio control, hand control

### Measurement data:



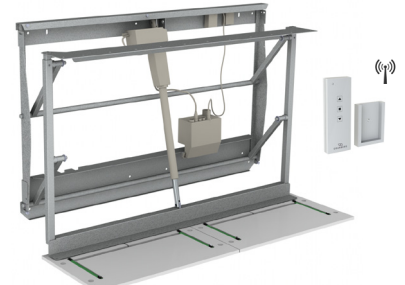







Cabinet width: 120.0-180.0 cm  
Cabinet height: 70.0-110.0 cm  
Cabinet depth: 26.0-40.0 cm

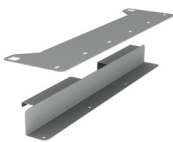
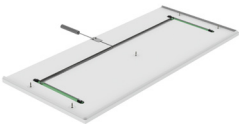

	Cabinet width (cm)	Planning width* (cm)	Cabinet beams, width (cm)	Art. no.
Safety plates (60.0 + 60.0 cm)	120.0	121.0	116.0	504-120-06
Safety plates (60.0 + 70.0 cm)	130.0	131.0	116.0	504-130-06
Safety plates (60.0 + 80.0 cm)	140.0	141.0	116.0	504-140-06
Safety plates (70.0 + 80.0 cm)	150.0	151.0	116.0	504-150-06
Safety plates (80.0 + 80.0 cm)	160.0	161.0	156.0	504-160-06
Safety plates (60.0 + 60.0 cm)	170.0	171.0	156.0	504-170-06
Safety plates (60.0+60.0+60.0 cm)	180.0	181.0	156.0	504-180-06

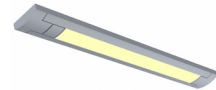
\* The planning width refers to the cabinets' width + gap for movement.

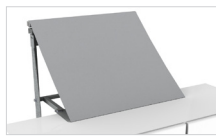

	<p><b>Lifting unit DIAGO 504</b> - Cabinet width 60.0-110.0 cm Colour: Alu-grey RAL 9006 Fits cabinets with height: 70.0-110.0 cm</p>	<p>504-055</p>		<p><b>Radio controlled - Fixed mounting</b> Control button with built-in radio control of a lift.</p> <p>The button is recess mounted in the front of the worktop lift. (Requires no wiring).</p> <p>The delivery includes receiver, battery and control button.</p> <p>Dimensions: 82 x 82 x 17 mm (52 mm total depth)</p>												
	<p><b>Lifting unit DIAGO 504</b> - Cabinet width 120.0-180.0 cm Colour: Alu-grey RAL 9006 Fits cabinets with height: 70.0-110.0 cm</p>	<p>504-115</p>	 <p>Radio control for 1 lift</p>  <p>Radio control for 2-5 lifts</p>	<p><b>Radio control - Hand control</b> Dimensions: 38 x 110 x 10 mm</p> <table border="1"> <tr><td>For one lift</td><td>61385</td></tr> <tr><td>For two lifts</td><td>61387</td></tr> <tr><td>For three lifts</td><td>61388</td></tr> <tr><td>For four lifts</td><td>61389</td></tr> <tr><td>For five lifts</td><td>61390</td></tr> </table>	For one lift	61385	For two lifts	61387	For three lifts	61388	For four lifts	61389	For five lifts	61390		
For one lift	61385															
For two lifts	61387															
For three lifts	61388															
For four lifts	61389															
For five lifts	61390															
	<p><b>Cabinet beams DIAGO 504</b> Upper and lower beam for the mounting of wall cabinets.</p> <table border="1"> <tr><td>For cabinets with width 60.0 cm</td><td>50450-056</td></tr> <tr><td>For cabinets with width 100.0-110.0 cm</td><td>50450-096</td></tr> <tr><td>For cabinets with width 120.0-150.0 cm</td><td>50450-116</td></tr> <tr><td>For cabinets with width 160.0-180.0 cm</td><td>50450-156</td></tr> </table>	For cabinets with width 60.0 cm	50450-056	For cabinets with width 100.0-110.0 cm	50450-096	For cabinets with width 120.0-150.0 cm	50450-116	For cabinets with width 160.0-180.0 cm	50450-156							
For cabinets with width 60.0 cm	50450-056															
For cabinets with width 100.0-110.0 cm	50450-096															
For cabinets with width 120.0-150.0 cm	50450-116															
For cabinets with width 160.0-180.0 cm	50450-156															
	<p><b>Safety plates DIAGO 504</b> The function of the safety plate is to stop the movement of the cabinet if the plate comes into contact with any object. Choose a plate that fits the width of the cabinet. Mounted under the wall cabinets Colour: White Thickness: 12 mm Depth: 350 - 400 mm</p> <table border="1"> <tr><td>Fits cabinets with width 40.0 cm</td><td>50431-4000</td></tr> <tr><td>Fits cabinets with width 45.0 cm</td><td>50431-4500</td></tr> <tr><td>Fits cabinets with width 50.0 cm</td><td>50431-5000</td></tr> <tr><td>Fits cabinets with width 60.0 cm</td><td>50431-6000</td></tr> <tr><td>Fits cabinets with width 70.0 cm</td><td>50431-7000</td></tr> <tr><td>Fits cabinets with width 80.0 cm</td><td>50431-8000</td></tr> </table> <p>For cabinets with width 90.0-180.0 cm, several safety plates are used together.</p>	Fits cabinets with width 40.0 cm	50431-4000	Fits cabinets with width 45.0 cm	50431-4500	Fits cabinets with width 50.0 cm	50431-5000	Fits cabinets with width 60.0 cm	50431-6000	Fits cabinets with width 70.0 cm	50431-7000	Fits cabinets with width 80.0 cm	50431-8000			<p><b>Extension frame for aluminium button</b> Enables surface mounting of aluminium buttons. Colour: White Dimensions: 82 x 82 x 52 mm</p> <p>61355</p>
Fits cabinets with width 40.0 cm	50431-4000															
Fits cabinets with width 45.0 cm	50431-4500															
Fits cabinets with width 50.0 cm	50431-5000															
Fits cabinets with width 60.0 cm	50431-6000															
Fits cabinets with width 70.0 cm	50431-7000															
Fits cabinets with width 80.0 cm	50431-8000															
	<p><b>Safety package for safety plate of your own design</b> The safety package contains micro-switch and cables for mounting in own board. Instructions with milling dimensions enclosed.</p> <p>Dimensions of board: Thickness: 12-16 mm Width: 400 - 800 mm Depth: 350 - 430 mm</p>	<p>50431-0000</p>		<p><b>LED Light ramp</b> Mounted under the safety plate. The lamp is energy-efficient and does not get hot. On/Off switch is on the lamp. Connects to a 230 V socket via the supplied transformer.</p> <p>Colour temperature: Warm white 3000K, 6.0 W Dimensions: 340 x 13 x 40 mm</p> <table border="1"> <tr><td>For fixed cabinets</td><td>61931</td></tr> <tr><td>For movable cabinets (with spiral cable)</td><td>61933</td></tr> </table>	For fixed cabinets	61931	For movable cabinets (with spiral cable)	61933								
For fixed cabinets	61931															
For movable cabinets (with spiral cable)	61933															
	<p><b>Control button, Mini</b> Wired, for recessed mounting Diameter: 20 mm</p>	<p>61315</p>		<p><b>LED Spotlights</b> Mounted under the safety plate. The lights are energy-efficient and do not get hot. Connects to a 230 V socket via the supplied transformer. 3.0 W Ø 70 mm, H=11 mm</p> <table border="1"> <tr><td>For fixed cabinets</td><td>61941</td></tr> <tr><td>For movable cabinets (with spiral cable)</td><td>61940</td></tr> </table>	For fixed cabinets	61941	For movable cabinets (with spiral cable)	61940								
For fixed cabinets	61941															
For movable cabinets (with spiral cable)	61940															
	<p><b>Control button in ALU-design</b> Wired, for recessed mounting Dimensions: 82 x 82 x 17 mm</p>	<p>61310</p>		<p><b>Cable connection package Lighting</b> Set with spiral cable and pull-relief for connection of own lighting on movable cabinet.</p> <p>61930</p>												
				<p><b>Screen</b> Mounted between the lift and the cabinet to conceal the lift as it is lowered. Colour: Grey</p> <table border="1"> <tr><td>Width 60.0 cm (For cabinet width 60.0 - 110.0 cm)</td><td>50460-060</td></tr> <tr><td>Width 120.0 cm (For cabinet width 120.0 - 180.0 cm)</td><td>50460-120</td></tr> </table>	Width 60.0 cm (For cabinet width 60.0 - 110.0 cm)	50460-060	Width 120.0 cm (For cabinet width 120.0 - 180.0 cm)	50460-120								
Width 60.0 cm (For cabinet width 60.0 - 110.0 cm)	50460-060															
Width 120.0 cm (For cabinet width 120.0 - 180.0 cm)	50460-120															

# Lifting systems for kitchen worktops

## Product overview

### BASELIFT 6300 / 6310

Page 28

- Motorised height-adjustable straight worktop lift
- Wall-mounted or floor-mounted, 30 cm adjustable
- Choose between high or low front



### BASELIFT Corner 6301 / 6311

Page 36

- Motorised height-adjustable corner worktop lift, 45° front, 90° wall
- Hob or sink bowl can be mounted in the corner module
- Wall-mounted or floor-mounted, 30 cm adjustable
- Choose between high or low front



### BASELIFT Corner 6302 / 6312

Page 44

- Motorised height-adjustable corner worktop lift, 45° front, 45° wall
- Hob or sink bowl can be mounted in the corner module
- Wall-mounted or floor-mounted, 30 cm adjustable
- Choose between high or low front



Our lifting systems for kitchen worktops are designed to be mounted in existing kitchens or as part of a new kitchen from any kitchen supplier. The worktops are available motorised or manually adjustable.

## BASELIFT Corner 6303 / 6313

Page 52

- Motorised height-adjustable corner worktop lift, 90° front, 90° wall
- Wall-mounted or floor-mounted, 30 cm adjustable
- Choose between high or low front



## SIDELIFT 6400

Page 60

- Motorised, straight worktop lift with side motors
- Cabinets can be hung under the entire worktop or under certain parts
- Floor-mounted, 30 cm adjustable
- 400 kg lifting power



## MANULIFT 6380

Page 68

- Manual height-adjustable straight worktop unit
- Wall-mounted or floor-mounted, 30 cm adjustable via a gas spring
- Choose between high or low front



# BASELIFT 6300 / 6310

Wall-mounted or floor-mounted motorised straight worktop lift

BASELIFT 6300/6310 is a straight, motorised worktop lift. Choose between wall-mounted or floor-mounted motors.

Under the worktop, space is left for the knees and legs. Installations under the worktop (motors, water, sewers) can be concealed by telescopic cover panels which gives the kitchen a neat look.

The motors work steplessly and adjust the worktop quickly and quietly to the desired height. The lift is equipped with a reliable safety system that guarantees safe operation without any risk of pinching.

The lift is prepared in the factory to facilitate easy installation.

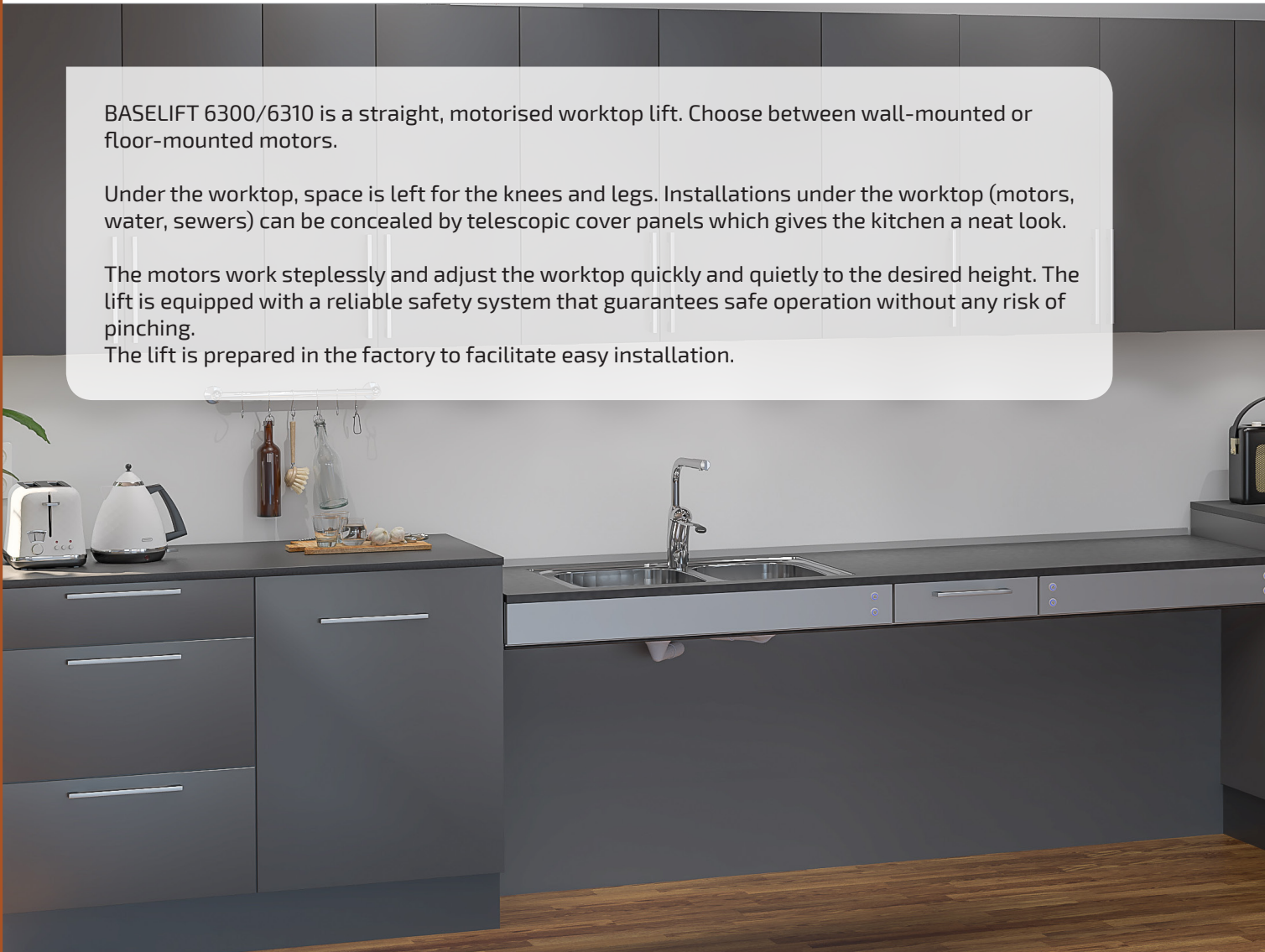

The front of BASELIFT 6300H/6310H hides the sink bowls and gives a nice front. Installations under the worktop are hidden by cover panels.



BASELIFT 6300H/6310H can be fitted with a drawer at the front.



BASELIFT 6300L/6310L has a 40 mm front, which provides good accessibility for seated work.



The low front of BASELIFT 6300L/6310L means the lift is suitable for hobs.



## Functions and advantages

- Motorised, straight worktop lift
- Height-adjustable 70-100 cm above floor (excl. top board)
- The frame depth is adjustable 56-59 cm to fit adjoining cabinet
- The upper part of the lifting system is delivered ready-mounted. The sides are pre-assembled and adjustable side-ways to suit the sink, hob and drawers
- The lifting system is adjustable at an angle to compensate for an inclined wall
- Integrated safety switch
- 10 cm free space under motors for electrical installation and piping. (Applies to wall-mounted model)
- Choose floor-mounted model if there is no stable wall

## Standard equipment

- Factory-mounted aluminium system with movable and tiltable brackets
- Wall-mounted or floor-mounted motors
- Safety switch

## Recommended additional options

- |                           |                            |
|---------------------------|----------------------------|
| - Control button          | - Drawer (not 6300L/6310L) |
| - Front                   | - Rear edge trim           |
| - Hose cover/cover panels | - Top board                |
| - Sink (not 6300L/6310L)  | - Hob                      |

## Useful information

- Fittings for top board and fronts enclosed
- The top board's depth must be 15 mm shallower than adjoining top boards (to provide a gap for tiles and movement)
- Width of the top board = width of the lift
- Sink bowls with a maximum height of 120 mm can be integrated (not 6300L/6310L)
- Electronics and motor system "Plug and Play"
- Width of front = width of lift - 4 mm  
Height of front: 6300H/6310H = 103 mm, 6300L/6310L = 40 mm  
Fittings enclosed
- Cover panels can hide installations under the worktop  
2 pcs width = width of lift - 10 mm, height 438 mm, thickness 12-20 mm

**Supplement with Plus module if you need a lift longer than 240 cm**  
The division should be as close to the middle as possible for even distribution of the engines.

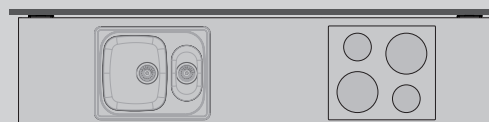
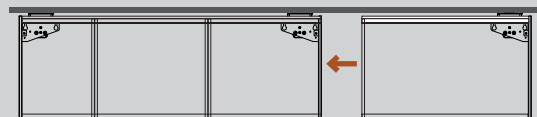

### Specify the location of drawers, sink and hob

The worktop is prepared in the factory. Drawers are mounted and sides assembled to facilitate the final mounting on the spot.

WALL-MOUNTED

6300H

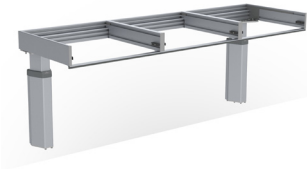

6300L

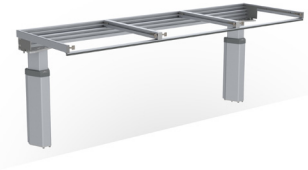

FLOOR-MOUNTED

6300H

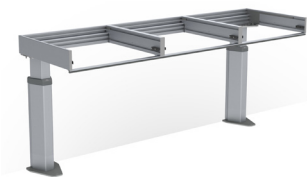

6300L



Specifications

<b>Mounting</b>	Wall or floor
<b>Height adjustment</b>	Motorised, steplessly adjustable 300 mm (700-1000 mm excl. top board)
<b>Speed</b>	30 mm / sec.
<b>Manoeuvring</b>	Recessed mounted button or radio control
<b>Safety</b>	The safety strip is placed under the front edge of the worktop. If anything touches the safety strip, the lifting unit stops
<b>Electricity connection</b>	Plug for 230 V, max 5.0 A
<b>Plumbing connections</b>	Connection is made with flexible hoses
<b>Lifting power</b>	100 kg
<b>IP Class</b>	IP 20
<b>Frame depth</b>	560-590 mm from wall
<b>Front height</b>	40 or 103 mm
<b>Dimensions cover panels</b>	2 pcs, width = width of the lift -10 mm, height 438 mm, thickness 12-20 mm
<b>Width top board</b>	Width = width of the lift
<b>Depth top board</b>	565-630 mm (15 mm shallower than worktops on fixed cabinets)
<b>Gap to the side to wall/adjoining cabinet</b>	5 mm
<b>Gap to wall (for tiling)</b>	15 mm
<b>Tiling</b>	From 700 mm above floor (alternatively all the way down to the floor)
<b>Delivery modules</b>	Ready-mounted worktop incl. safety switch, motors
<b>Fittings enclosed</b>	Bracket for front panels and top board
<b>Material specifications</b>	Aluminium frame
<b>Guarantee</b>	2 years
	CE

Measurement data

(mm)

WALL-MOUNTED: 6300H/6300L

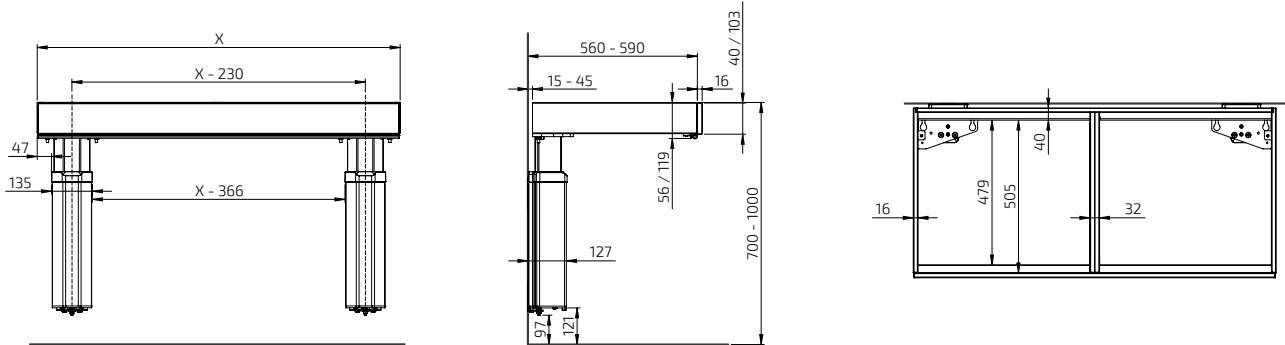

FLOOR-MOUNTED: 6310H/6310L

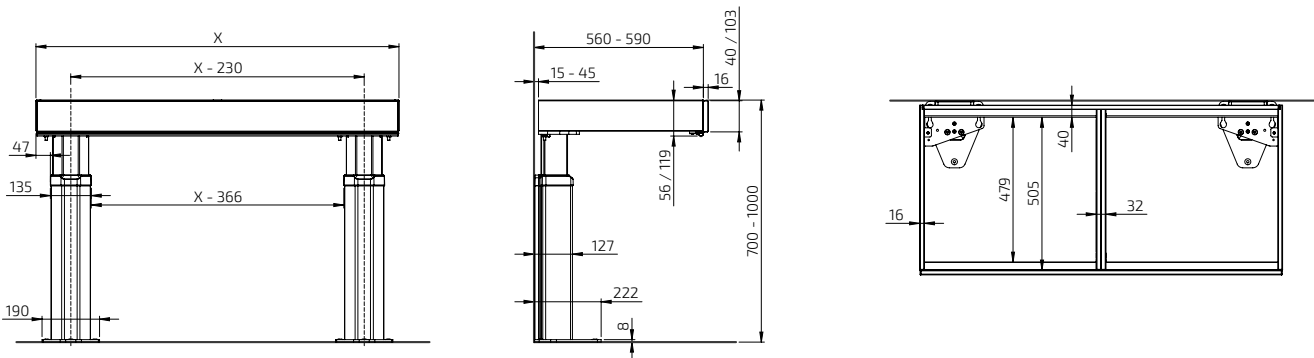

**BASELIFT 6300HA**

Wall-mounted lifting unit 59.0-100.0 cm width



Width (cm)	Art. no.
59.0	6300HA-059
60.0	6300HA-060
69.0	6300HA-069
70.0	6300HA-070
79.0	6300HA-079
80.0	6300HA-080
89.0	6300HA-089
90.0	6300HA-090
99.0	6300HA-099
100.0	6300HA-100

**BASELIFT 6310HA**

Floor-mounted lifting unit 59.0-100.0 cm width



Width (cm)	Art. no.
59.0	6310HA-059
60.0	6310HA-060
69.0	6310HA-069
70.0	6310HA-070
79.0	6310HA-079
80.0	6310HA-080
89.0	6310HA-089
90.0	6310HA-090
99.0	6310HA-099
100.0	6310HA-100

**BASELIFT 6300HA**

Wall-mounted lifting unit 109.0 - 180.0 cm width



109.0	6300HA-109
110.0	6300HA-110
119.0	6300HA-109
120.0	6300HA-120
129.0	6300HA-109
130.0	6300HA-130
139.0	6300HA-139
140.0	6300HA-140
149.0	6300HA-149
150.0	6300HA-150
159.0	6300HA-159
160.0	6300HA-160
169.0	6300HA-169
170.0	6300HA-170
179.0	6300HA-179
180.0	6300HA-180

**BASELIFT 6310HA**

Floor-mounted lifting unit 109.0 - 180.0 cm width

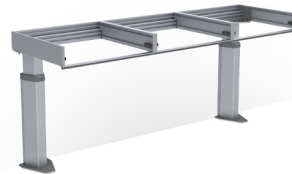

109.0	6310HA-109
110.0	6310HA-110
119.0	6310HA-109
120.0	6310HA-120
129.0	6310HA-109
130.0	6310HA-130
139.0	6310HA-139
140.0	6310HA-140
149.0	6310HA-149
150.0	6310HA-140
159.0	6310HA-149
160.0	6310HA-160
169.0	6310HA-149
170.0	6310HA-170
179.0	6310HA-179
180.0	6310HA-170

**BASELIFT 6300HA**

Wall-mounted lifting unit 189.0 - 240.0 cm width



189.0	6300HA-189
190.0	6300HA-189
199.0	6300HA-189
200.0	6300HA-200
209.0	6300HA-209
210.0	6300HA-210
219.0	6300HA-219
220.0	6300HA-220
229.0	6300HA-220
230.0	6300HA-230
239.0	6300HA-239
240.0	6300HA-240

**BASELIFT 6310HA**

Floor-mounted lifting unit 189.0 - 240.0 cm width



189.0	6310HA-189
190.0	6310HA-190
199.0	6310HA-199
200.0	6310HA-200
209.0	6310HA-209
210.0	6310HA-210
219.0	6310HA-219
220.0	6310HA-220
229.0	6310HA-219
230.0	6310HA-230
239.0	6310HA-239
240.0	6310HA-240

**Plus module BASELIFT 6306HA**

Wall-mounted Plus module 40.0-100.0 cm width



40.0	6306HA-040
50.0	6306HA-050
60.0	6306HA-060
70.0	6306HA-070
80.0	6306HA-080
90.0	6306HA-090
100.0	6306HA-100

**Plus module BASELIFT 6316HA**

Floor-mounted Plus module 40.0-100.0 cm width



40.0	6316HA-040
50.0	6316HA-050
60.0	6316HA-060
70.0	6316HA-070
80.0	6316HA-080
90.0	6316HA-090
100.0	6316HA-100

**Plus module BASELIFT 6306HA**

Wall-mounted Plus module 110.0-180.0 cm width

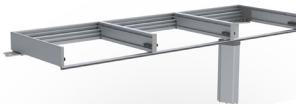

110.0	6306HA-110
120.0	6306HA-120
130.0	6306HA-130
140.0	6306HA-140
150.0	6306HA-150
160.0	6306HA-160
170.0	6306HA-170
180.0	6306HA-180

**Plus module BASELIFT 6316HA**

Floor-mounted Plus module 110.0-180.0 cm width

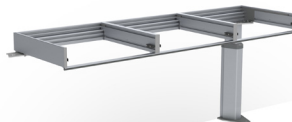

110.0	6316HA-110
120.0	6316HA-120
130.0	6316HA-130
140.0	6316HA-140
150.0	6316HA-150
160.0	6316HA-160
170.0	6316HA-170
180.0	6316HA-180

**Plus module BASELIFT 6306HA**

Wall-mounted Plusmodule 190.0-240.0 cm width

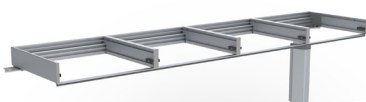

190.0	6306HA-190
200.0	6306HA-200
210.0	6306HA-210
220.0	6306HA-220
230.0	6306HA-230
240.0	6306HA-240











**Plus module BASELIFT 6316HA**









Floor-mounted Plus module 190.0-240.0 cm width



190.0	6316HA-190
200.0	6316HA-200
210.0	6316HA-210
220.0	6316HA-220
230.0	6316HA-230
240.0	6316HA-240

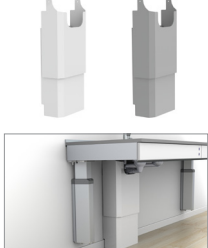
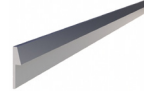

	<p><b>Control button in ALU-design</b> Wired, for recessed mounting Dimensions: 82 x 82 x 17 mm</p>	61320
	<p><b>Control button, Mini</b> Wired, for recessed mounting Diameter: 20 mm</p>	61318
	<p><b>Radio control - Hand control</b> Dimensions: 38 x 110 x 10 mm</p> <p>For one lift</p> <p>For two lifts</p> <p>For three lifts</p> <p>For four lifts</p> <p>For five lifts</p>	61385
		61387
		61388
		61389
		61390
	<p><b>Multi-compartment frame, ALU-design</b> Collects power socket, power switch or control buttons in a multi-compartment frame.</p> <p>Two-compartment frame: 153 x 82 x 9 mm</p> <p>Three-compartment frame: 225 x 82 x 9 mm</p>	61352 61353
	<p><b>Socket, ALU-design</b> Earthed socket 230 V with flap cover. Dimensions: 82 x 82 x 17 mm Only Europe</p>	61330
	<p><b>Power switch, ALU-design</b> For lighting, for example. The button has a sign for optional marking. Dimensions: 82 x 82 x 17 mm</p>	61331
	<p><b>Safety lock</b> Prevents unauthorised use. Dimensions: 23 x 9 mm</p>	61360
	<p><b>Front, white-lacquered aluminium</b> Replace xxx with cm when ordering. Example, 385H-040-01 for 40.0 cm</p> <p>Lacquered aluminium, white RAL 9003 Height: 103 mm Optional length, 20.0-340.0 cm</p>	385H-xxx-01
	<p><b>Front, anodised aluminium</b> Replace xxx with cm when ordering. Example, 385H-040-06 for 40.0 cm</p> <p>Anodised aluminium Height: 103 mm Optional length, 20.0-340.0 cm</p>	385H-xxx-06
	<p><b>Integrated drawer with full extension and soft-close or push-to-open function</b> Depth: 470 mm, height: 85 mm Colour: Anthracite (RAL 9004)</p>	465H-030 465H-040 465H-050 465H-060 465H-080  466H-030 466H-040 466H-050 466H-060 466H-080

	<p><b>Cutlery compartment</b></p>	<p>Fits 30.0 cm wide drawer</p> <p>Fits 40.0 cm wide drawer</p> <p>Fits 50.0 cm wide drawer</p> <p>Fits 60.0 cm wide drawer</p> <p>Fits 80.0 cm wide drawer</p>	463-030 463-040 463-050 463-060 463-080
	<p><b>Safety strip</b> Used if pinch protection is desired on the gable end (by an open side). Length: 370 mm, Height: 10 mm</p>		61430
	<p><b>Safety panel, short end</b> Used when the worktop lift's underside passes over adjoining furnishings. Height: 263 - 800 mm, Depth: 400 mm <b>For a worktop lift with cover panels</b></p>		61442 61443
	<p><b>Safety panel, short end</b> Used when the worktop lift's underside passes over adjoining furnishings. Height: 263 - 800 mm, Depth: 545 mm <b>For a worktop lift without cover panels</b></p>		61444 61445
	<p><b>Hob cover under worktop lift</b> Provides a smooth underside. Used under the hob.</p>	<p>White-lacquered metal RAL 9003</p> <p>60.0 cm</p> <p>70.0 cm</p> <p>80.0 cm</p> <p>90.0 cm</p> <p>100.0 cm</p>	6266-060 6266-070 6266-080 6266-090 6266-100
	<p><b>Cover panels</b> Used to cover installations under the worktop.</p>	<p>12 mm white melamine, 2 pcs height 438 mm</p> <p>2 pcs are required for lengths over 2400 mm</p>	6260-240
	<p><b>Fittings set for cover panels</b> Used to mount cover panels that conceal installations under the worktop.</p>	<p>Colour: Alu-grey RAL 9006</p> <p>2 pcs are required for lengths over 2400 mm</p>	6260-005
	<p><b>Hose cover</b> The hose cover is mounted anywhere under the worktop, (next to motors, if applicable) to provide a neat coverage of hoses when the cover panels are not in use. Fittings are included.</p>	<p>Width: 410 mm, Depth: 200 mm</p> <p>White plastic</p> <p>Grey plastic</p>	61504-01 61504-06
	<p><b>Rear edge trim in aluminium for top board</b> Mounted behind top board. Brushed aluminium Height above top board: 20 mm Thickness behind top board: 3 mm (per metre)</p>		6943-06
	<p><b>Height-adjustment kit</b> Used to change stroke after installation. Contains programming box and memory adapter.</p>		61400

**BASELIFT 6300LA**

Wall-mounted lifting unit 59.0-100.0 cm width



Width (cm)	Art. no.
59.0	6300LA-059
60.0	6300LA-060
69.0	6300LA-069
70.0	6300LA-070
79.0	6300LA-079
80.0	6300LA-080
89.0	6300LA-089
90.0	6300LA-090
99.0	6300LA-099
100.0	6300LA-100

**BASELIFT 6310LA**

Floor-mounted lifting unit 59.0-100.0 cm width



Width (cm)	Art. no.
59.0	6310LA-059
60.0	6310LA-060
69.0	6310LA-069
70.0	6310LA-070
79.0	6310LA-079
80.0	6310LA-080
89.0	6310LA-089
90.0	6310LA-090
99.0	6310LA-099
100.0	6310LA-100

**BASELIFT 6300LA**

Wall-mounted lifting unit 109.0 - 180.0 cm width



109.0	6300LA-109
110.0	6300LA-110
119.0	6300LA-119
120.0	6300LA-120
129.0	6300LA-129
130.0	6300LA-130
139.0	6300LA-139
140.0	6300LA-140
149.0	6300LA-149
150.0	6300LA-150
159.0	6300LA-159
160.0	6300LA-160
169.0	6300LA-169
170.0	6300LA-170
179.0	6300LA-179
180.0	6300LA-180

**BASELIFT 6310LA**

Floor-mounted lifting unit 109.0 - 180.0 cm width



109.0	6310LA-109
110.0	6310LA-110
119.0	6310LA-119
120.0	6310LA-120
129.0	6310LA-129
130.0	6310LA-130
139.0	6310LA-139
140.0	6310LA-140
149.0	6310LA-149
150.0	6310LA-150
159.0	6310LA-159
160.0	6310LA-160
169.0	6310LA-169
170.0	6310LA-170
179.0	6310LA-179
180.0	6310LA-180

**BASELIFT 6300LA**

Wall-mounted lifting unit 189.0 - 240.0 cm width



189.0	6300LA-189
190.0	6300LA-190
199.0	6300LA-199
200.0	6300LA-200
209.0	6300LA-209
210.0	6300LA-210
219.0	6300LA-219
220.0	6300LA-220
229.0	6300LA-229
230.0	6300LA-230
239.0	6300LA-239
240.0	6300LA-240

**BASELIFT 6310LA**

Floor-mounted lifting unit 189.0 - 240.0 cm width



189.0	6310LA-189
190.0	6310LA-190
199.0	6310LA-199
200.0	6310LA-200
209.0	6310LA-209
210.0	6310LA-210
219.0	6310LA-219
220.0	6310LA-220
229.0	6310LA-229
230.0	6310LA-230
239.0	6310LA-239
240.0	6310LA-240

**Plus module BASELIFT 6306LA**

Wall-mounted Plus module 40.0-100.0 cm width



40.0	6306LA-040
50.0	6306LA-050
60.0	6306LA-060
70.0	6306LA-070
80.0	6306LA-080
90.0	6306LA-090
100.0	6306LA-100

**Plus module BASELIFT 6316LA**

Floor-mounted Plus module 40.0-100.0 cm width



40.0	6316LA-040
50.0	6316LA-050
60.0	6316LA-060
70.0	6316LA-070
80.0	6316LA-080
90.0	6316LA-090
100.0	6316LA-100

**Plus module BASELIFT 6306LA**

Wall-mounted Plus module 110.0-180.0 cm width



110.0	6306LA-110
120.0	6306LA-120
130.0	6306LA-130
140.0	6306LA-140
150.0	6306LA-150
160.0	6306LA-160
170.0	6306LA-170
180.0	6306LA-180

**Plus module BASELIFT 6316LA**

Floor-mounted Plus module 110.0-180.0 cm width



110.0	6316LA-110
120.0	6316LA-120
130.0	6316LA-130
140.0	6316LA-140
150.0	6316LA-150
160.0	6316LA-160
170.0	6316LA-170
180.0	6316LA-180

**Plus module BASELIFT 6306LA**

Wall-mounted Plus module 190.0-240.0 cm width

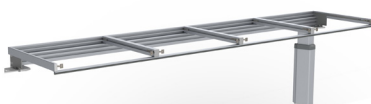













190.0	6306LA-190
200.0	6306LA-200
210.0	6306LA-210
220.0	6306LA-220
230.0	6306LA-230
240.0	6306LA-240

**Plus module BASELIFT 6316LA**

Floor-mounted Plus module 190.0-240.0 cm width

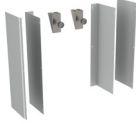
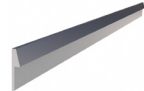

190.0	6316LA-190
200.0	6316LA-200
210.0	6316LA-210
220.0	6316LA-220
230.0	6316LA-230
240.0	6316LA-240

	<p><b>Control button, Mini</b> Wired, for recessed mounting Diameter: 20 mm</p> <p>61318</p>		<p><b>Safety strip</b> Used if pinch protection is desired on the gable end (by an open side). Length: 370 mm Height: 10 mm</p> <p>61430</p>
 <p>Radio control for 1 lift</p>  <p>Radio control for 2-5 lifts</p>	<p><b>Radio control - Hand control</b> Dimensions: 38 x 110 x 10 mm</p> <p>For one lift 61385</p> <p>For two lifts 61387</p> <p>For three lifts 61388</p> <p>For four lifts 61389</p> <p>For five lifts 61390</p>		<p><b>Safety panel, short end</b> Used when the worktop lift's underside passes over adjoining interior fittings. Height: 263 mm, Depth: 400 mm <b>For a worktop lift with cover panels</b></p> <p>Left 61442</p> <p>Right 61443</p>
	<p><b>Safety lock</b> Prevents unauthorised use. Dimensions: 23 x 9 mm</p> <p>61360</p>		<p><b>Safety panel, short end</b> Used when the worktop lift's underside passes over adjoining furnishings. Height: 263 mm, Depth: 545 mm <b>For a worktop lift without cover panels</b></p> <p>Left 61444</p> <p>Right 61445</p>
	<p><b>Front, white-lacquered aluminium</b> Replace xxx with cm when ordering. Example, 385L-040-01 for 40.0 cm</p> <p>Lacquered aluminium, white RAL 9003 Height: 40 mm Optional length, 20.0-340.0 cm</p> <p>385L-xxx-01</p>		<p><b>Hob cover under worktop lift</b> Provides a smooth underside. Used under the hob.</p> <p>White-lacquered metal RAL 9003</p> <p>60.0 cm 6266-060</p> <p>70.0 cm 6266-070</p> <p>80.0 cm 6266-080</p> <p>90.0 cm 6266-090</p> <p>100.0 cm 6266-100</p>
	<p><b>Front, anodised aluminium</b> Replace xxx with cm when ordering. Example, 385L-040-06 for 40.0 cm</p> <p>Anodised aluminium Height: 40 mm Optional length, 20.0-340.0 cm</p> <p>385L-XXX-06</p>		<p><b>Cover panels</b> Used to cover installations under the worktop.</p> <p>Length is adapted to worktop lift's length.</p> <p>12 mm white melamine, 2 pcs height 438 mm 2 pcs are required for lengths over 2400 mm</p> <p>6260-240</p>
			<p><b>Fittings set for cover panels</b> Used to mount cover panels that conceal installations under the worktop.</p> <p>Colour: Alu-grey RAL 9006 2 pcs are required for lengths over 2400 mm</p> <p>6260-005</p>
			<p><b>Rear edge trim in aluminium for top board</b> Mounted behind top board. Brushed aluminium Height above top board: 20 mm Thickness behind top board: 3 mm (per metre)</p> <p>6943-06</p>
			<p><b>Height-adjustment kit</b> Used to change stroke after installation. Contains programming box and memory adapter.</p> <p>61400</p>

# BASELIFT Corner 6301 / 6311

Wall-mounted or floor-mounted motorised corner worktop lift, 45° front edge, 90° wall

BASELIFT Corner 6301/6311 is a motorised corner worktop lift with 45° front edge and 90° rear edge. Choose between wall-mounted or floor-mounted motors.

Under the worktop, space is left for the knees and legs. Installations under the worktop, (motors, water, sewers), can be concealed by telescopic cover panels which gives the kitchen a neat look.

The motors work steplessly and adjust the worktop quickly and quietly to the desired height. The lift is equipped with a reliable safety system that guarantees safe operation without any risk of pinching. The lift is prepared in the factory to facilitate easy installation.

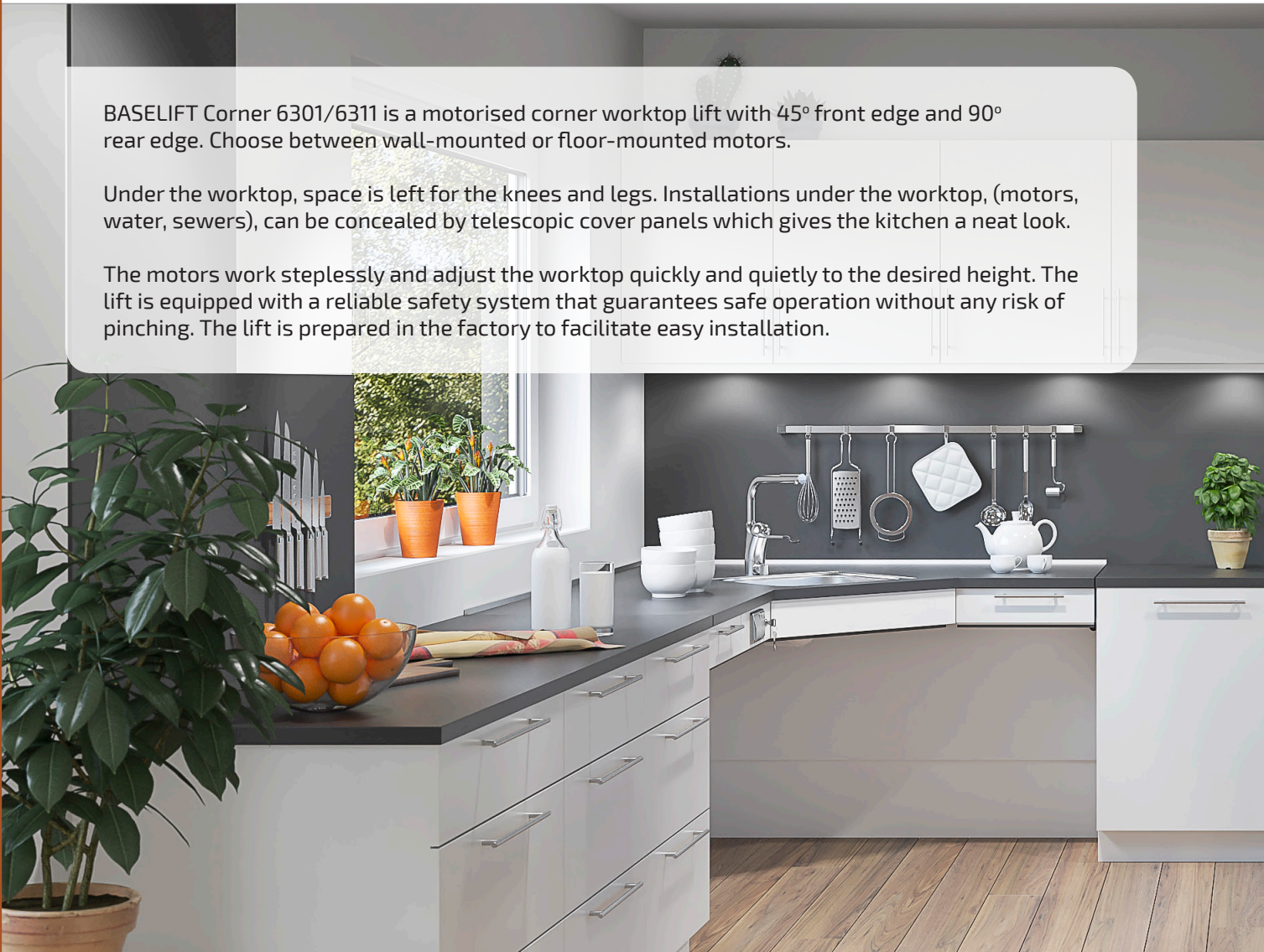

Corner worktop lift with 45° slanted front edge provides ample legroom under the worktop while providing good access to the work surfaces on the sides. Installations under the worktop are hidden by cover panels.



Inset sink with a sink bowl can be integrated with the corner module. It is also possible to integrate a hob with the corner module.



A drawer can be integrated with the worktop.



### Functions and advantages

- Motorised corner worktop lift, 45° front edge, 90° wall
- Hob or sink bowl can be mounted in the corner module
- Height-adjustable 70-100 cm above the floor (excl. top board)
- The frame depth is adjustable 56-59 cm to fit adjoining cabinet
- The upper part of the lifting system is delivered ready-mounted. The sides are pre-assembled and adjustable side-ways to suit the sink, hob and drawers
- The lifting system is adjustable at an angle to compensate for an inclined wall
- Integrated safety switch
- 10 cm free space under motors for electrical installation and piping. (Applies to wall-mounted model)
- Choose floor-mounted model if there is no stable wall

### Standard equipment

- Factory-mounted aluminium system with movable and tiltable brackets
- Wall-mounted or floor-mounted motors
- Safety switch

### Recommended additional options

- Control button
- Front
- Hose cover/cover panels
- Sink (Not 6301L/6311L)
- Drawer (Not 6301L/6311L)
- Rear edge trim
- Top board
- Hob

### Useful information

- Fittings for top board and fronts enclosed
- The top board's depth must be 15 mm shallower than adjoining top boards (to provide a gap for tiles and movement)
- Width of the top board = width of the lift
- Sink bowls with a maximum height of 120 mm can be integrated (Not 6301L/6311L)
- Electronics and motor system "Plug and Play"
- Width of front = width of lift - 4 mm  
Height of front: 6301H/6311H = 103 mm, 6301L/6311L = 40 mm  
Fittings enclosed
- Cover panels can hide installations under the worktop  
2 pcs, height 438 mm, thickness 12-20 mm

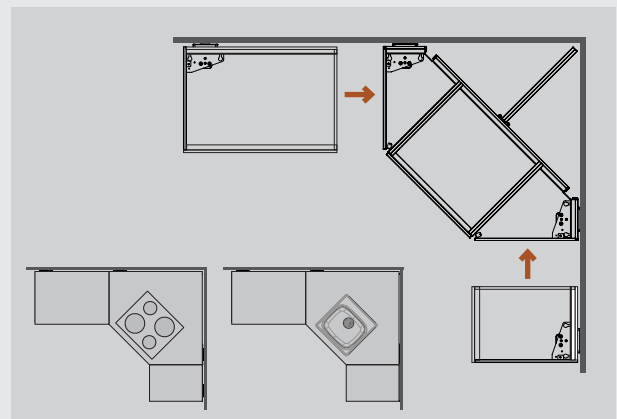

The corner module is equipped with two motors and can be used as one unit. Supplement with Plus modules to obtain the desired length on the left and right wings. A hob or sink bowl can be placed in the corner.

Specify the position of the drawers, sink and hob  
The worktop is prepared in the factory. Drawers are mounted and sides assembled to facilitate the final mounting on the spot.

WALL-MOUNTED

6301H

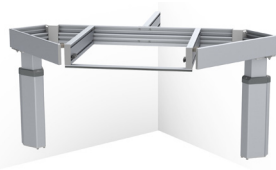

6301L



FLOOR-MOUNTED

6311H



6311L



Specifications

<b>Mounting</b>	Wall or floor
<b>Corner solution</b>	45° front edge, 90° wall
<b>Height adjustment</b>	Motorised, steplessly adjustable 300 mm (700-1000 mm excl. top board)
<b>Speed</b>	30 mm / sec.
<b>Manoeuvring</b>	Recessed mounted button or radio control
<b>Safety</b>	The safety strip is placed under the front edge of the worktop. If anything touches the safety strip, the lifting unit stops
<b>Electricity connection</b>	Plug for 230 V, max 5.0 A
<b>Plumbing connections</b>	Connection is made with flexible hoses
<b>Lifting power</b>	100 kg
<b>IP Class</b>	IP 20
<b>Frame depth</b>	560-590 mm from wall
<b>Front height</b>	40 or 103 mm
<b>Dimensions cover panels</b>	2 pcs, height 438 mm, thickness 12-20 mm
<b>Width top board</b>	Width = width of the lift
<b>Depth top board</b>	565-630 mm (15 mm shallower than worktops on fixed cabinets)
<b>Gap to the side to wall/adjoining cabinet</b>	5 mm
<b>Gap to wall (for tiling)</b>	15 mm
<b>Tiling</b>	From 700 mm above floor (alternatively all the way down to the floor)
<b>Delivery modules</b>	Ready-mounted worktop incl. safety switch, motors
<b>Fittings enclosed</b>	Bracket for fronts and top board
<b>Material specifications</b>	Aluminium frame
<b>Guarantee</b>	2 years
	CE

Measurement data

(mm)

WALL-MOUNTED: 6301H/6301L

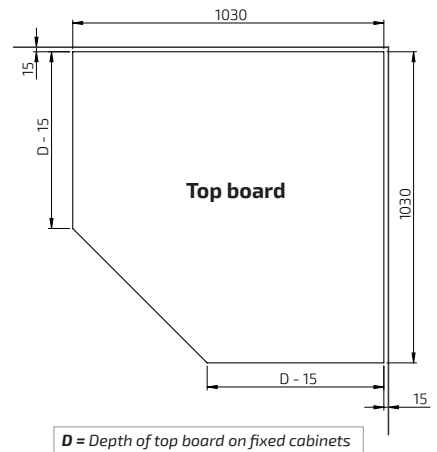
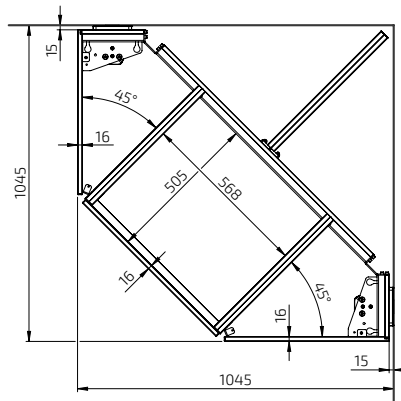
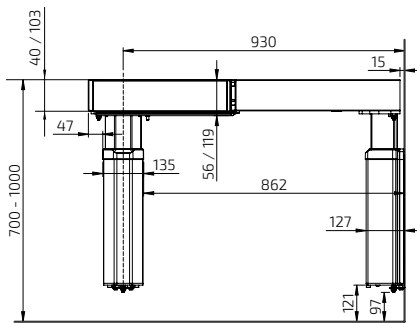

FLOOR-MOUNTED: 6311H / 6311L

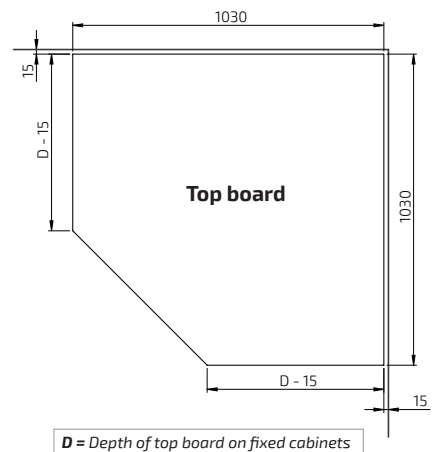
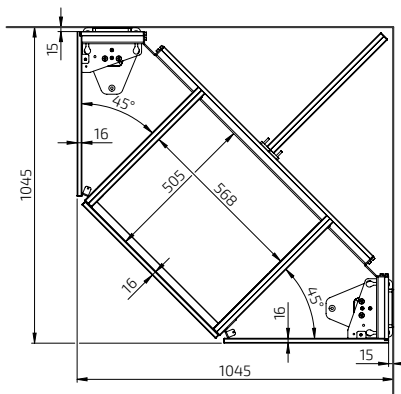
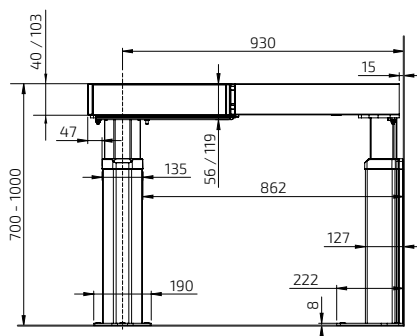

**BASELIFT Corner 6301HA - Wall-mounted**

Lifting unit 104.5 x 104.5 cm  
 For 103 mm front  
 Frame depth 56.0 - 59.0 cm  
 2 motors  
 Safety switch

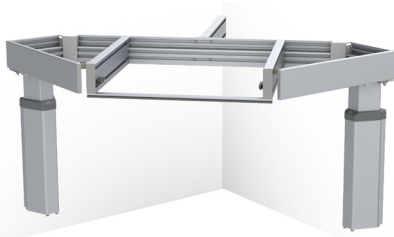

**BASELIFT Corner 6311HA - Floor-mounted**

Lifting unit 104.5 x 104.5 cm  
 For 103 mm front  
 Frame depth 56.0 - 59.0 cm  
 2 motors  
 Safety switch



	Width (cm)	Art. no.
	104.5	6301HA-1045

**Plus module Left 6305HA, 40.0-100.0 cm**



40.0	6305HA-040
50.0	6305HA-050
60.0	6305HA-060
70.0	6305HA-070
80.0	6305HA-080
90.0	6305HA-090
100.0	6305HA-100

	Width (cm)	Art. no.
	104.5	6311HA-1045

**Plus module Left 6315HA, 40.0 - 100.0 cm**



40.0	6315HA-040
50.0	6315HA-150
60.0	6315HA-060
70.0	6315HA-070
80.0	6315HA-080
90.0	6315HA-090
100.0	6315HA-100

**Plus module Left 6305HA, 110.0-180.0 cm**



110.0	6305HA-110
120.0	6305HA-120
130.0	6305HA-130
140.0	6305HA-140
150.0	6305HA-150
160.0	6305HA-160
170.0	6305HA-170
180.0	6305HA-180

**Plus module Left 6315HA, 110.0 - 180.0 cm**



110.0	6315HA-110
120.0	6315HA-120
130.0	6315HA-130
140.0	6315HA-140
150.0	6315HA-150
160.0	6315HA-160
170.0	6315HA-170
180.0	6315HA-180

**Plus module Left 6305HA, 190.0-240.0 cm**



190.0	6305HA-190
200.0	6305HA-200
210.0	6305HA-210
220.0	6305HA-220
230.0	6305HA-230
240.0	6305HA-240

**Plus module Left 6315HA, 190.0 - 240.0 cm**



190.0	6315HA-190
200.0	6315HA-200
210.0	6315HA-210
220.0	6315HA-220
230.0	6315HA-230
240.0	6315HA-240

**Plus module Right 6306HA, 40.0-100.0 cm**



40.0	6306HA-040
50.0	6306HA-050
60.0	6306HA-060
70.0	6306HA-070
80.0	6306HA-080
90.0	6306HA-090
100.0	6306HA-100

**Plus module Right 6316HA, 40.0 - 100.0 cm**



40.0	6316HA-040
50.0	6316HA-050
60.0	6316HA-160
70.0	6316HA-070
80.0	6316HA-080
90.0	6316HA-090
100.0	6316HA-100

**Plus module Right 6306HA, 110.0 - 180.0 cm**



110.0	6306HA-110
120.0	6306HA-120
130.0	6306HA-130
140.0	6306HA-140
150.0	6306HA-150
160.0	6306HA-160
170.0	6306HA-170
180.0	6306HA-180

**Plus module Right 6316HA, 110.0 - 180.0 cm**

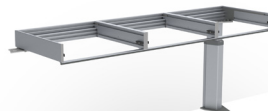

110.0	6316HA-110
120.0	6316HA-120
130.0	6316HA-130
140.0	6316HA-140
150.0	6316HA-150
160.0	6316HA-160
170.0	6316HA-170
180.0	6316HA-180

**Plus module Right 6306HA, 190.0 - 180.0 cm**





















190.0	6306HA-190
200.0	6306HA-200
210.0	6306HA-210
220.0	6306HA-220
230.0	6306HA-230
240.0	6306HA-240

**Plus module Right 6316HA, 190.0 - 240.0 cm**

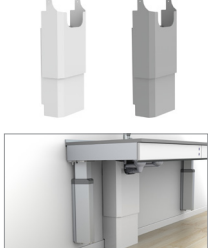

190.0	6316HA-190
200.0	6316HA-200
210.0	6316HA-210
220.0	6316HA-220
230.0	6316HA-230
240.0	6316HA-240

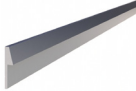

	<p><b>Control button in ALU-design</b> Wired, for recessed mounting Dimensions: 82 x 82 x 17 mm</p> <p>61320</p>		<p><b>Cutlery compartment</b></p> <table border="1"> <tr><td>Fits 30.0 cm wide drawer</td><td>463-030</td></tr> <tr><td>Fits 40.0 cm wide drawer</td><td>463-040</td></tr> <tr><td>Fits 50.0 cm wide drawer</td><td>463-050</td></tr> <tr><td>Fits 60.0 cm wide drawer</td><td>463-060</td></tr> <tr><td>Fits 80.0 cm wide drawer</td><td>463-080</td></tr> </table>	Fits 30.0 cm wide drawer	463-030	Fits 40.0 cm wide drawer	463-040	Fits 50.0 cm wide drawer	463-050	Fits 60.0 cm wide drawer	463-060	Fits 80.0 cm wide drawer	463-080										
Fits 30.0 cm wide drawer	463-030																						
Fits 40.0 cm wide drawer	463-040																						
Fits 50.0 cm wide drawer	463-050																						
Fits 60.0 cm wide drawer	463-060																						
Fits 80.0 cm wide drawer	463-080																						
	<p><b>Control button, Mini</b> Wired, for recessed mounting Diameter: 20 mm</p> <p>61318</p>		<p><b>Safety strip</b> Used if pinch protection is desired on the gable end (by an open side). Length: 370 mm, Height: 10 mm</p> <p>61430</p>																				
	<p><b>Radio control - Hand control</b> Dimensions: 38 x 110 x 10 mm</p> <table border="1"> <tr><td>For one lift</td><td>61385</td></tr> <tr><td>For two lifts</td><td>61387</td></tr> <tr><td>For three lifts</td><td>61388</td></tr> <tr><td>For four lifts</td><td>61389</td></tr> <tr><td>For five lifts</td><td>61390</td></tr> </table>	For one lift	61385	For two lifts	61387	For three lifts	61388	For four lifts	61389	For five lifts	61390		<p><b>Safety panel, short end</b> Used when the worktop lift's underside passes over adjoining furnishings. Height: 263 - 800 mm, Depth: 400 mm <b>For a worktop lift with cover panels</b></p> <table border="1"> <tr><td>Left</td><td>61442</td></tr> <tr><td>Right</td><td>61443</td></tr> </table>	Left	61442	Right	61443						
For one lift	61385																						
For two lifts	61387																						
For three lifts	61388																						
For four lifts	61389																						
For five lifts	61390																						
Left	61442																						
Right	61443																						
	<p><b>Multi-compartment frame, ALU-design</b> Collects power socket, power switch or control buttons in a multi-compartment frame.</p> <table border="1"> <tr><td>Two-compartment frame: 153 x 82 x 9 mm</td><td>61352</td></tr> <tr><td>Three-compartment frame: 225 x 82 x 9 mm</td><td>61353</td></tr> </table>	Two-compartment frame: 153 x 82 x 9 mm	61352	Three-compartment frame: 225 x 82 x 9 mm	61353		<p><b>Safety panel, short end</b> Used when the worktop lift's underside passes over adjoining furnishings. Height: 263 - 800 mm, Depth: 545 mm <b>For a worktop lift without cover panels</b></p> <table border="1"> <tr><td>Left</td><td>61444</td></tr> <tr><td>Right</td><td>61445</td></tr> </table>	Left	61444	Right	61445												
Two-compartment frame: 153 x 82 x 9 mm	61352																						
Three-compartment frame: 225 x 82 x 9 mm	61353																						
Left	61444																						
Right	61445																						
	<p><b>Socket, ALU-design</b> Earthed socket 230 V with flap cover. Dimensions: 82 x 82 x 17 mm Only Europe</p> <p>61330</p>		<p><b>Hob cover under worktop lift</b> Provides a smooth underside. Used under the hob.</p> <table border="1"> <tr><td>White-lacquered metal RAL 9003</td><td></td></tr> <tr><td>60.0 cm</td><td>6266-060</td></tr> <tr><td>70.0 cm</td><td>6266-070</td></tr> <tr><td>80.0 cm</td><td>6266-080</td></tr> <tr><td>90.0 cm</td><td>6266-090</td></tr> <tr><td>100.0 cm</td><td>6266-100</td></tr> </table>	White-lacquered metal RAL 9003		60.0 cm	6266-060	70.0 cm	6266-070	80.0 cm	6266-080	90.0 cm	6266-090	100.0 cm	6266-100								
White-lacquered metal RAL 9003																							
60.0 cm	6266-060																						
70.0 cm	6266-070																						
80.0 cm	6266-080																						
90.0 cm	6266-090																						
100.0 cm	6266-100																						
	<p><b>Power switch, ALU-design</b> For lighting, for example. The button has a sign for optional marking. Dimensions: 82 x 82 x 17 mm</p> <p>61331</p>		<p><b>Cover panels</b> Used to cover installations under the worktop.</p> <table border="1"> <tr><td>12 mm white melamine, 2 pcs height 438 mm</td><td></td></tr> <tr><td>2 pcs are required for lengths over 2400 mm</td><td>6260-240</td></tr> </table>	12 mm white melamine, 2 pcs height 438 mm		2 pcs are required for lengths over 2400 mm	6260-240																
12 mm white melamine, 2 pcs height 438 mm																							
2 pcs are required for lengths over 2400 mm	6260-240																						
	<p><b>Safety lock</b> Prevents unauthorised use. Dimensions: 23 x 9 mm</p> <p>61360</p>		<p><b>Fittings set for cover panels</b> Used to mount cover panels that conceal installations under the worktop.</p> <table border="1"> <tr><td>Colour: Alu-grey RAL 9006</td><td></td></tr> <tr><td>2 pcs are required for lengths over 2400 mm</td><td>6260-005</td></tr> </table>	Colour: Alu-grey RAL 9006		2 pcs are required for lengths over 2400 mm	6260-005																
Colour: Alu-grey RAL 9006																							
2 pcs are required for lengths over 2400 mm	6260-005																						
	<p><b>Front, white-lacquered aluminium</b> Replace xxx with cm when ordering. Example, 385H-040-01 for 40.0 cm</p> <p>Lacquered aluminium, white RAL 9003 Height: 103 mm Optional length, 20.0-340.0 cm</p> <p>385H-xxx-01</p>		<p><b>Hose cover</b> The hose cover is mounted anywhere under the worktop, (next to motors, if applicable) to provide a neat coverage of hoses when the cover panels are not in use. Fittings are included.</p> <table border="1"> <tr><td>Width: 410 mm, Depth: 200 mm</td><td></td></tr> <tr><td>White plastic</td><td>61504-01</td></tr> <tr><td>Grey plastic</td><td>61504-06</td></tr> </table>	Width: 410 mm, Depth: 200 mm		White plastic	61504-01	Grey plastic	61504-06														
Width: 410 mm, Depth: 200 mm																							
White plastic	61504-01																						
Grey plastic	61504-06																						
	<p><b>Front, anodised aluminium</b> Replace xxx with cm when ordering. Example, 385H-040-06 for 40.0 cm</p> <p>Anodised aluminium Height: 103 mm Optional length, 20.0-340.0 cm</p> <p>385H-xxx-06</p>		<p><b>Rear edge trim in aluminium for top board</b> Mounted behind top board. Brushed aluminium Height above top board: 20 mm Thickness behind top board: 3 mm (per metre)</p> <p>6943-06</p>																				
	<p><b>Integrated drawer with full extension and soft-close or push-to-open function</b> Depth: 470 mm, height: 85 mm Colour: Anthracite (RAL 9004)</p> <table border="1"> <tr><td>30.0 cm</td><td>465H-030</td></tr> <tr><td>40.0 cm</td><td>465H-040</td></tr> <tr><td>50.0 cm</td><td>465H-050</td></tr> <tr><td>60.0 cm</td><td>465H-060</td></tr> <tr><td>80.0 cm</td><td>465H-080</td></tr> <tr><td>30.0 cm - Push-to-open function</td><td>466H-030</td></tr> <tr><td>40.0 cm - Push-to-open function</td><td>466H-040</td></tr> <tr><td>50.0 cm - Push-to-open function</td><td>466H-050</td></tr> <tr><td>60.0 cm - Push-to-open function</td><td>466H-060</td></tr> <tr><td>80.0 cm - Push-to-open function</td><td>466H-080</td></tr> </table>	30.0 cm	465H-030	40.0 cm	465H-040	50.0 cm	465H-050	60.0 cm	465H-060	80.0 cm	465H-080	30.0 cm - Push-to-open function	466H-030	40.0 cm - Push-to-open function	466H-040	50.0 cm - Push-to-open function	466H-050	60.0 cm - Push-to-open function	466H-060	80.0 cm - Push-to-open function	466H-080		<p><b>Height-adjustment kit</b> Used to change stroke after installation. Contains programming box and memory adapter.</p> <p>61400</p>
30.0 cm	465H-030																						
40.0 cm	465H-040																						
50.0 cm	465H-050																						
60.0 cm	465H-060																						
80.0 cm	465H-080																						
30.0 cm - Push-to-open function	466H-030																						
40.0 cm - Push-to-open function	466H-040																						
50.0 cm - Push-to-open function	466H-050																						
60.0 cm - Push-to-open function	466H-060																						
80.0 cm - Push-to-open function	466H-080																						

**BASELIFT Corner 6301LA - Wall-mounted**

Lifting unit 104.5 x 104.5 cm  
 For 40 mm front  
 Frame depth 56.0 - 59.0 cm  
 2 motors  
 Safety switch



**BASELIFT Corner 6311LA-Floor-mounted**

Lifting unit 104.5 x 104.5 cm  
 For 40 mm front  
 Frame depth 56.0-59.0 cm  
 2 motors  
 Safety switch

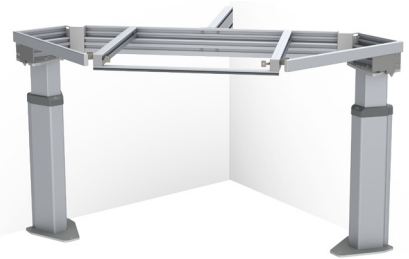

	Width (cm)	Art. no.
	104.5	6301LA-1045

	Width (cm)	Art. no.
	104.5	6311LA-1045

**Plus module Left 6305LA, 40.0-100.0 cm**



40.0	6305LA-040
50.0	6305LA-050
60.0	6305LA-060
70.0	6305LA-070
80.0	6305LA-080
90.0	6305LA-090
100.0	6305LA-100

**Plus module Left 6315LA, 40.0 - 100.0 cm**



40.0	6315LA-040
50.0	6315LA-150
60.0	6315LA-060
70.0	6315LA-070
80.0	6315LA-080
90.0	6315LA-090
100.0	6315LA-100

**Plus module Left 6305LA, 110.0-180.0 cm**



110.0	6305LA-110
120.0	6305LA-120
130.0	6305LA-130
140.0	6305LA-140
150.0	6305LA-150
160.0	6305LA-160
170.0	6305LA-170
180.0	6305LA-180

**Plus module Left 6315LA, 110.0 - 180.0 cm**



110.0	6315LA-110
120.0	6315LA-120
130.0	6315LA-130
140.0	6315LA-140
150.0	6315LA-150
160.0	6315LA-160
170.0	6315LA-170
180.0	6315LA-180

**Plus module Left 6305LA, 190.0-240.0 cm**



190.0	6305LA-190
200.0	6305LA-200
210.0	6305LA-210
220.0	6305LA-220
230.0	6305LA-230
240.0	6305LA-240

**Plus module Left 6315LA, 190.0 - 240.0 cm**



190.0	6315LA-190
200.0	6315LA-200
210.0	6315LA-210
220.0	6315LA-220
230.0	6315LA-230
240.0	6315LA-240

**Plus module Right 6306LA, 40.0 - 100.0 cm**



40.0	6306LA-040
50.0	6306LA-050
60.0	6306LA-060
70.0	6306LA-070
80.0	6306LA-080
90.0	6306LA-090
100.0	6306LA-100

**Plus module Right 6316LA, 40.0 - 100.0 cm**



40.0	6316LA-040
50.0	6316LA-050
60.0	6316LA-160
70.0	6316LA-070
80.0	6316LA-080
90.0	6316LA-090
100.0	6316LA-100

**Plus module Right 6306LA, 110.0 - 180.0 cm**



110.0	6306LA-100
120.0	6306LA-120
130.0	6306LA-130
140.0	6306LA-140
150.0	6306LA-150
160.0	6306LA-160
170.0	6306LA-170
180.0	6306LA-180

**Plus module Right 6316LA, 110.0 - 180.0 cm**



110.0	6316LA-110
120.0	6316LA-120
130.0	6316LA-130
140.0	6316LA-140
150.0	6316LA-150
160.0	6316LA-160
170.0	6316LA-170
180.0	6316LA-180

**Plus module Right 6306LA, 190.0 - 240.0 cm**

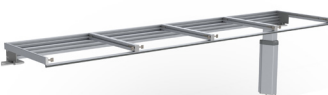













190.0	6306LA-190
200.0	6306LA-200
210.0	6306LA-210
220.0	6306LA-220
230.0	6306LA-230
240.0	6306LA-240

**Plus module Right 6316LA, 190.0 - 240.0 cm**

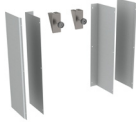
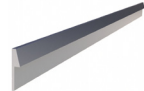

190.0	6316LA-190
200.0	6316LA-200
210.0	6316LA-210
220.0	6316LA-220
230.0	6316LA-230
240.0	6316LA-240

	<p><b>Control button, Mini</b></p> <p>Wired, for recessed mounting Diameter: 20 mm</p> <p>61318</p>		<p><b>Safety strip</b></p> <p>Used if pinch protection is desired on the gable end (by an open side). Length: 370 mm Height: 10 mm</p> <p>61430</p>
 <p>Radio control for 1 lift</p>  <p>Radio control for 2-5 lifts</p>	<p><b>Radio control - Hand control</b> Dimensions: 38 x 110 x 10 mm</p> <p>For one lift 61385</p> <p>For two lifts 61387</p> <p>For three lifts 61388</p> <p>For four lifts 61389</p> <p>For five lifts 61390</p>		<p><b>Safety panel, short end</b> Used when the worktop lift's underside passes over adjoining interior fittings. Height: 263 mm, Depth: 400 mm <b>For a worktop lift with cover panels</b></p> <p>Left 61442</p> <p>Right 61443</p>
	<p><b>Safety lock</b> Prevents unauthorised use. Dimensions: 23 x 9 mm</p> <p>61360</p>		<p><b>Safety panel, short end</b> Used when the worktop lift's underside passes over adjoining furnishings. Height: 263 mm, Depth: 545 mm <b>For a worktop lift without cover panels</b></p> <p>Left 61444</p> <p>Right 61445</p>
	<p><b>Front, white-lacquered aluminium</b></p> <p>Replace xxx with cm when ordering. Example, 385L-040-01 for 40.0 cm</p> <p>Lacquered aluminium, white RAL 9003 Height: 40 mm Optional length, 20.0-340.0 cm</p> <p>385L-xxx-01</p>		<p><b>Hob cover under worktop lift</b></p> <p>Provides a smooth underside. Used under the hob.</p> <p>White-lacquered metal RAL 9003</p> <p>60.0 cm 6266-060</p> <p>70.0 cm 6266-070</p> <p>80.0 cm 6266-080</p> <p>90.0 cm 6266-090</p> <p>100.0 cm 6266-100</p>
	<p><b>Front, anodised aluminium</b></p> <p>Replace xxx with cm when ordering. Example, 385L-040-06 for 40.0 cm</p> <p>Anodised aluminium Height: 40 mm Optional length, 20.0-340.0 cm</p> <p>385L-XXX-06</p>		<p><b>Cover panels</b> Used to cover installations under the worktop.</p> <p>Length is adapted to worktop lift's length.</p> <p>12 mm white melamine, 2 pcs height 438 mm 2 pcs are required for lengths over 2400 mm</p> <p>6260-240</p>
			<p><b>Fittings set for cover panels</b> Used to mount cover panels that conceal installations under the worktop.</p> <p>Colour: Alu-grey RAL 9006 2 pcs are required for lengths over 2400 mm</p> <p>6260-005</p>
			<p><b>Rear edge trim in aluminium for top board</b> Mounted behind top board. Brushed aluminium Height above top board: 20 mm Thickness behind top board: 3 mm (per metre)</p> <p>6943-06</p>
			<p><b>Height-adjustment kit</b> Used to change stroke after installation. Contains programming box and memory adapter.</p> <p>61400</p>

# BASELIFT Corner 6302 / 6312

Wall-mounted or floor-mounted motorised corner worktop lift, 90° front edge, 45° wall



Corner worktop lift with 45° slanted front edge and rear edge gives the kitchen an exclusive look, while providing good access to the work surfaces on the sides. Installations under the worktop are hidden by cover panels.

BASELIFT Corner 6302/6312 is a motorised corner worktop lift with 45° front edge and 45° rear edge. Choose between wall-mounted or floor-mounted motors.

Under the worktop, space is left for the knees and legs. Installations under the worktop, (motors, water, sewers) can be concealed with telescopic cover panels which gives the kitchen a neat look.

The motors work steplessly and adjust the worktop quickly and quietly to the desired height. The lift is equipped with a reliable safety system that guarantees safe operation without any risk of pinching. The lift is prepared in the factory to facilitate easy installation.

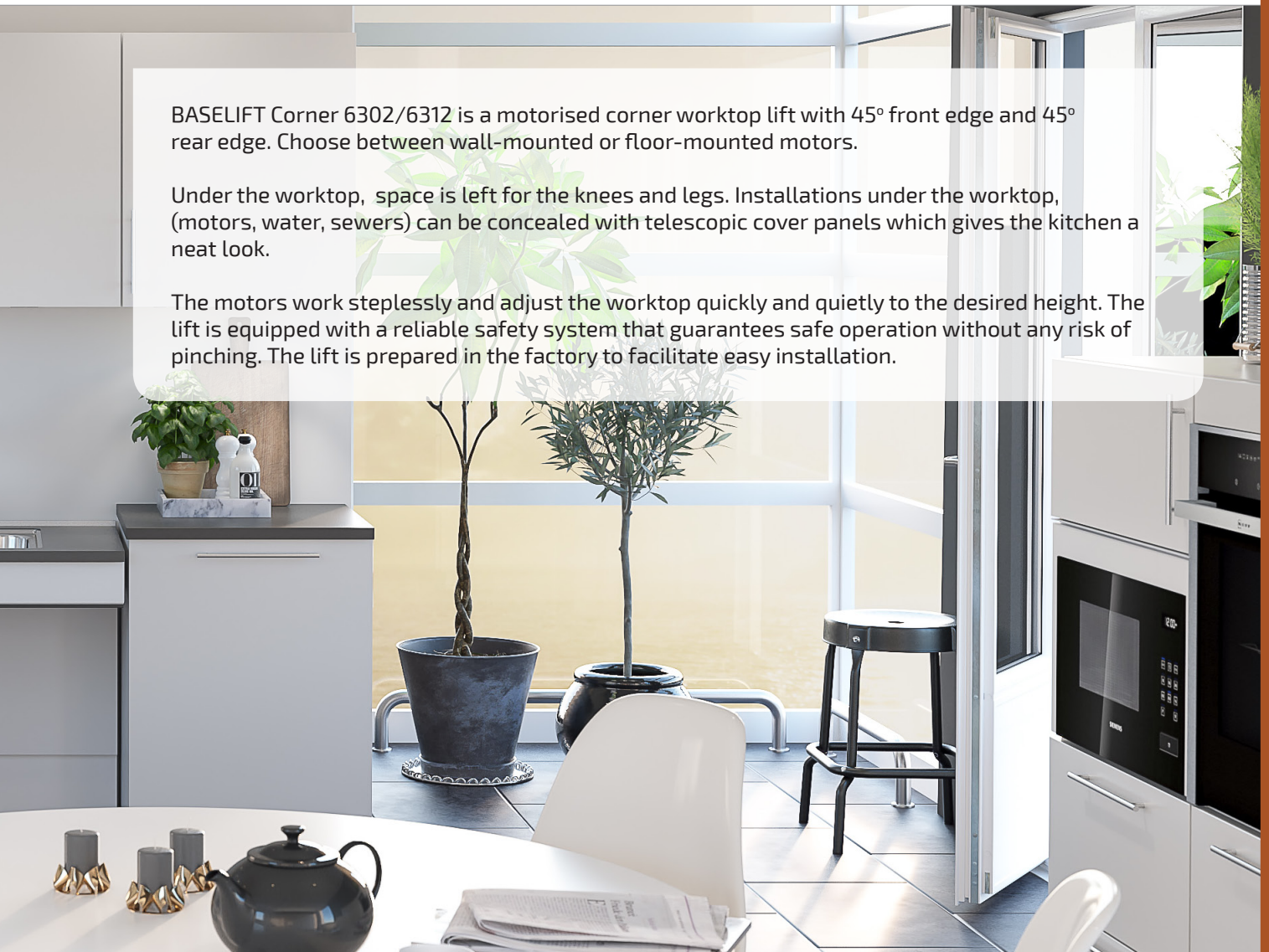

Hob can be integrated with the corner module. It is also possible to integrate the inset sink with a sink bowl in the corner module.



A drawer can be integrated with the worktop.



### Functions and advantages

- Motorised corner worktop lift, 45° front edge, 45° wall
- Hob or sink bowl can be mounted in the corner module
- Height-adjustable 70-100 cm above the floor (excl. top board)
- The frame depth is adjustable 56-59 cm to fit adjoining cabinet
- The upper part of the lifting system is delivered ready-mounted. The sides are pre-assembled and adjustable side-ways to suit the sink, hob and drawers
- The lifting system is adjustable at an angle to compensate for an inclined wall
- Integrated safety switch
- 10 cm free space under motors for electrical installation and piping. (Applies to wall-mounted model)
- Choose floor-mounted model if there is no stable wall

### Standard equipment

- Factory-mounted aluminium system with movable and tiltable brackets
- Wall-mounted or floor-mounted motors
- Safety switch

### Recommended additional options

- Control button
- Front
- Hose cover/cover panels
- Sink (Not 6302L/6312L)
- Drawer (Not 6302L/6312L)
- Rear edge trim
- Top board
- Hob

### Useful information

- Fittings for top board and fronts enclosed
- The top board's depth must be 15 mm shallower than adjoining top boards (to provide a gap for tiles and movement)
- Width of the top board = width of the lift
- Sink bowls with a maximum height of 120 mm can be integrated (Not 6302L/6312L)
- Electronics and motor system "Plug and Play"
- Width of front = width of lift - 4 mm  
Height of front: 6302H/6312H = 103 mm, 6302L/6312L = 40 mm  
Fittings enclosed
- Cover panels can hide installations under the worktop  
2 pcs, height 438 mm, thickness 12-20 mm

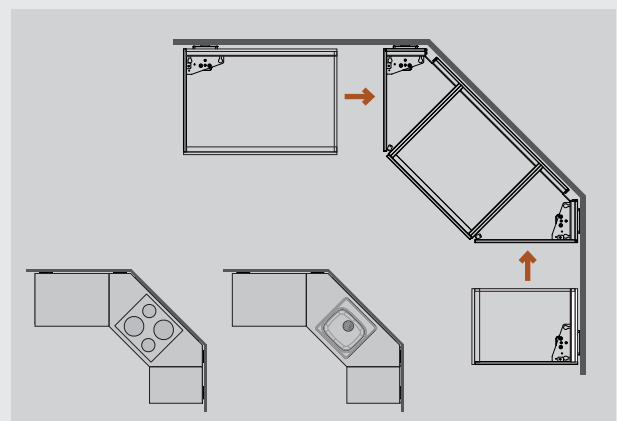

The corner module is equipped with two motors and can be used as one unit. Supplement with Plus modules to obtain the desired length on the left and right wings. A hob or sink bowl can be placed in the corner.

Specify the position of the drawers, sink and hob  
The worktop is prepared in the factory. Drawers are mounted and sides assembled to facilitate the final mounting on the spot.

WALL-MOUNTED

6302H



6302L



FLOOR-MOUNTED

6312H



6312L



Specifications

<b>Mounting</b>	Wall or floor
<b>Corner solution</b>	45° front edge, 45° wall
<b>Height adjustment</b>	Motorised, steplessly adjustable 300 mm (700-1000 mm excl. top board)
<b>Speed</b>	30 mm / sec.
<b>Manoeuvring</b>	Recessed mounted button or radio control
<b>Safety</b>	The safety strip is placed under the front edge of the worktop. If anything touches the safety strip, the lifting unit stops
<b>Electricity connection</b>	Plug for 230 V, max 5.0 A
<b>Plumbing connections</b>	Connection is made with flexible hoses
<b>Lifting power</b>	100 kg
<b>IP Class</b>	IP 20
<b>Frame depth</b>	560-590 mm from wall
<b>Front height</b>	40 or 103 mm
<b>Dimensions cover panels</b>	2 pcs, height 438 mm, thickness 12-20 mm
<b>Width top board</b>	Width = width of the lift
<b>Depth top board</b>	565-630 mm (15 mm shallower than worktops on fixed cabinets)
<b>Gap to the side to wall/adjoining cabinet</b>	5 mm
<b>Gap to wall (for tiling)</b>	15 mm
<b>Tiling</b>	From 700 mm above floor (alternatively all the way down to the floor)
<b>Delivery modules</b>	Ready-mounted worktop incl. safety switch, motors
<b>Fittings enclosed</b>	Bracket for fronts and top board
<b>Material specifications</b>	Aluminium frame
<b>Guarantee</b>	2 years
	CE

Measurement data

(mm)

WALL-MOUNTED: 6302H/6302L

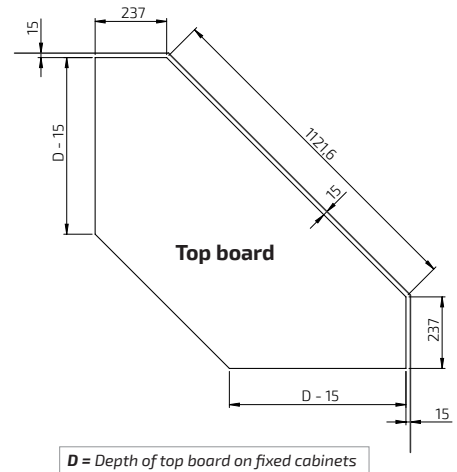
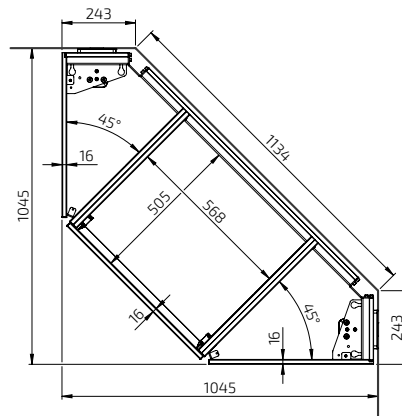
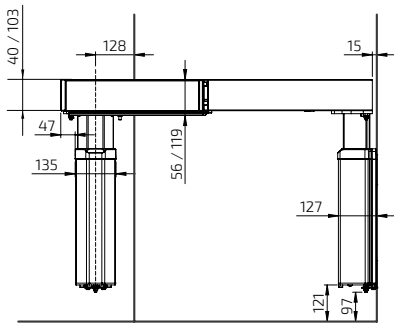

FLOOR-MOUNTED: 6312H / 6312L

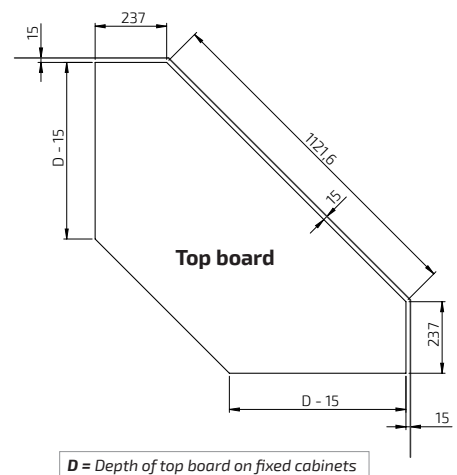
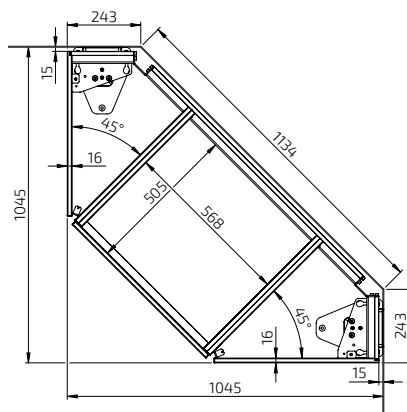
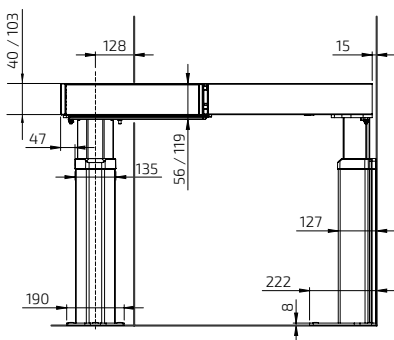

**BASELIFT Corner 6302HA - Wall-mounted**

Lifting unit 104.5 x 104.5 cm  
 For 103 mm front  
 Frame depth 56.0 - 59.0 cm  
 2 motors  
 Safety switch



**BASELIFT Corner 6302HA - Floor-mounted**

Lifting unit 104.5 x 104.5 cm  
 For 103 mm front  
 Frame depth 56.0 - 59.0 cm  
 2 motors  
 Safety switch



	Width (cm)	Art. no.
	104.5	6302HA-1045

	Width (cm)	Art. no.
	104.5	6312HA-1045

**Plus module Left 6305HA, 40.0-100.0 cm**



40.0	6305HA-040
50.0	6305HA-050
60.0	6305HA-060
70.0	6305HA-070
80.0	6305HA-080
90.0	6305HA-090
100.0	6305HA-100

**Plus module Left 6315HA, 40.0 - 100.0 cm**



40.0	6315HA-040
50.0	6315HA-150
60.0	6315HA-060
70.0	6315HA-070
80.0	6315HA-080
90.0	6315HA-090
100.0	6315HA-100

**Plus module Left 6305HA, 110.0-180.0 cm**



110.0	6305HA-110
120.0	6305HA-120
130.0	6305HA-130
140.0	6305HA-140
150.0	6305HA-150
160.0	6305HA-160
170.0	6305HA-170
180.0	6305HA-180

**Plus module Left 6315HA, 110.0 - 180.0 cm**



110.0	6315HA-110
120.0	6315HA-120
130.0	6315HA-130
140.0	6315HA-140
150.0	6315HA-150
160.0	6315HA-160
170.0	6315HA-170
180.0	6315HA-180

**Plus module Left 6305HA, 190.0-240.0 cm**



190.0	6305HA-190
200.0	6305HA-200
210.0	6305HA-210
220.0	6305HA-220
230.0	6305HA-230
240.0	6305HA-240

**Plus module Left 6315HA, 190.0 - 240.0 cm**



190.0	6315HA-190
200.0	6315HA-200
210.0	6315HA-210
220.0	6315HA-220
230.0	6315HA-230
240.0	6315HA-240

**Plus module Right 6306HA, 40.0-100.0 cm**



40.0	6306HA-040
50.0	6306HA-050
60.0	6306HA-060
70.0	6306HA-070
80.0	6306HA-080
90.0	6306HA-090
100.0	6306HA-100

**Plus module Right 6316HA, 40.0 - 100.0 cm**



40.0	6316HA-040
50.0	6316HA-050
60.0	6316HA-160
70.0	6316HA-070
80.0	6316HA-080
90.0	6316HA-090
100.0	6316HA-100

**Plus module Right 6306HA, 110.0 - 180.0 cm**



110.0	6306HA-110
120.0	6306HA-120
130.0	6306HA-130
140.0	6306HA-140
150.0	6306HA-150
160.0	6306HA-160
170.0	6306HA-170
180.0	6306HA-180

**Plus module Right 6316HA, 110.0 - 180.0 cm**



110.0	6316HA-110
120.0	6316HA-120
130.0	6316HA-130
140.0	6316HA-140
150.0	6316HA-150
160.0	6316HA-160
170.0	6316HA-170
180.0	6316HA-180

**Plus module Right 6306HA, 190.0 - 180.0 cm**







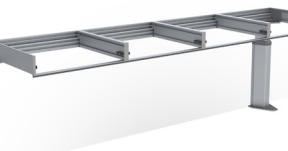





190.0	6306HA-190
200.0	6306HA-200
210.0	6306HA-210
220.0	6306HA-220
230.0	6306HA-230
240.0	6306HA-240











**Plus module Right 6316HA, 190.0 - 240.0 cm**



190.0	6316HA-190
200.0	6316HA-200
210.0	6316HA-210
220.0	6316HA-220
230.0	6316HA-230
240.0	6316HA-240

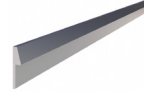

	<b>Control button in ALU-design</b> Wired, for recessed mounting Dimensions: 82 x 82 x 17 mm	61320
	<b>Control button, Mini</b> Wired, for recessed mounting Diameter: 20 mm	61318
	<b>Radio control - Hand control</b> Dimensions: 38 x 110 x 10 mm	For one lift
		For two lifts
		For three lifts
		For four lifts
		For five lifts
	<b>Multi-compartment frame, ALU-design</b> Collects power socket, power switch or control buttons in a multi-compartment frame.	
	Two-compartment frame: 153 x 82 x 9 mm	61352
	Three-compartment frame: 225 x 82 x 9 mm	61353
	<b>Socket, ALU-design</b> Earthed socket 230 V with flap cover. Dimensions: 82 x 82 x 17 mm Only Europe	61330
	<b>Power switch, ALU-design</b> For lighting, for example. The button has a sign for optional marking. Dimensions: 82 x 82 x 17 mm	61331
	<b>Safety lock</b> Prevents unauthorised use. Dimensions: 23 x 9 mm	61360
	<b>Front, white-lacquered aluminium</b> Replace xxx with cm when ordering. Example, 385H-040-01 for 40.0 cm	
	Lacquered aluminium, white RAL 9003 Height: 103 mm Optional length, 20.0-340.0 cm	385H-xxx-01
	<b>Front, anodised aluminium</b> Replace xxx with cm when ordering. Example, 385H-040-06 for 40.0 cm	
	Anodised aluminium Height: 103 mm Optional length, 20.0-340.0 cm	385H-xxx-06
	<b>Integrated drawer with full extension and soft-close or push-to-open function</b> Depth: 470 mm, height: 85 mm Colour: Anthracite (RAL 9004)	
	30.0 cm	465H-030
	40.0 cm	465H-040
	50.0 cm	465H-050
	60.0 cm	465H-060
	80.0 cm	465H-080
	30.0 cm - Push-to-open function	466H-030
	40.0 cm - Push-to-open function	466H-040
	50.0 cm - Push-to-open function	466H-050
	60.0 cm - Push-to-open function	466H-060
	80.0 cm - Push-to-open function	466H-080

	<b>Cutlery compartment</b>	
	Fits 30.0 cm wide drawer	463-030
	Fits 40.0 cm wide drawer	463-040
	Fits 50.0 cm wide drawer	463-050
	Fits 60.0 cm wide drawer	463-060
	Fits 80.0 cm wide drawer	463-080
	<b>Safety strip</b> Used if pinch protection is desired on the gable end (by an open side). Length: 370 mm, Height: 10 mm	61430
	<b>Safety panel, short end</b> Used when the worktop lift's underside passes over adjoining furnishings. Height: 263 - 800 mm, Depth: 400 mm <b>For a worktop lift with cover panels</b>	
	Left	61442
	Right	61443
	<b>Safety panel, short end</b> Used when the worktop lift's underside passes over adjoining furnishings. Height: 263 - 800 mm, Depth: 545 mm <b>For a worktop lift without cover panels</b>	
	Left	61444
	Right	61445
	<b>Hob cover under worktop lift</b> Provides a smooth underside. Used under the hob.	
	White-lacquered metal RAL 9003	
	60.0 cm	6266-060
	70.0 cm	6266-070
	80.0 cm	6266-080
	90.0 cm	6266-090
	100.0 cm	6266-100
	<b>Cover panels</b> Used to cover installations under the worktop.	
	12 mm white melamine, 2 pcs height 438 mm	
	2 pcs are required for lengths over 2400 mm	6260-240
	<b>Fittings set for cover panels</b> Used to mount cover panels that conceal installations under the worktop.	
	Colour: Alu-grey RAL 9006	
	2 pcs are required for lengths over 2400 mm	6260-005
	<b>Hose cover</b> The hose cover is mounted anywhere under the worktop, (next to motors, if applicable) to provide a neat coverage of hoses when the cover panels are not in use. Fittings are included.	
	Width: 410 mm, Depth: 200 mm	
	White plastic	61504-01
	Grey plastic	61504-06
	<b>Rear edge trim in aluminium for top board</b> Mounted behind top board. Brushed aluminium Height above top board: 20 mm Thickness behind top board: 3 mm (per metre)	6943-06
	<b>Height-adjustment kit</b> Used to change stroke after installation. Contains programming box and memory adapter.	61400

**BASELIFT Corner 6302LA - Wall-mounted**

Lifting unit 104.5 x 104.5 cm  
 For 40 mm front  
 Frame depth 56.0 - 59.0 cm  
 2 motors  
 Safety switch



**BASELIFT Corner 6312LA - Floor-mounted**

Lifting unit 104.5 x 104.5 cm  
 For 40 mm front  
 Frame depth 56.0 - 59.0 cm  
 2 motors  
 Safety switch



	Width (cm)	Art. no.
	104.5	6302LA-1045

	Width (cm)	Art. no.
	104.5	6312LA-1045

**Plus module Left 6305LA, 40.0-100.0 cm**



40.0	6305LA-040
50.0	6305LA-050
60.0	6305LA-060
70.0	6305LA-070
80.0	6305LA-080
90.0	6305LA-090
100.0	6305LA-100

**Plus module Left 6315LA, 40.0 - 100.0 cm**



40.0	6315LA-040
50.0	6315LA-150
60.0	6315LA-060
70.0	6315LA-070
80.0	6315LA-080
90.0	6315LA-090
100.0	6315LA-100

**Plus module Left 6305LA, 110.0-180.0 cm**



110.0	6305LA-110
120.0	6305LA-120
130.0	6305LA-130
140.0	6305LA-140
150.0	6305LA-150
160.0	6305LA-160
170.0	6305LA-170
180.0	6305LA-180

**Plus module Left 6315LA, 110.0 - 180.0 cm**



110.0	6315LA-110
120.0	6315LA-120
130.0	6315LA-130
140.0	6315LA-140
150.0	6315LA-150
160.0	6315LA-160
170.0	6315LA-170
180.0	6315LA-180

**Plus module Left 6305LA, 190.0-240.0 cm**



190.0	6305LA-190
200.0	6305LA-200
210.0	6305LA-210
220.0	6305LA-220
230.0	6305LA-230
240.0	6305LA-240

**Plus module Left 6315LA, 190.0 - 240.0 cm**



190.0	6315LA-190
200.0	6315LA-200
210.0	6315LA-210
220.0	6315LA-220
230.0	6315LA-230
240.0	6315LA-240

**Plus module Right 6306LA, 40.0 - 100.0 cm**



40.0	6306LA-040
50.0	6306LA-050
60.0	6306LA-060
70.0	6306LA-070
80.0	6306LA-080
90.0	6306LA-090
100.0	6306LA-100

**Plus module Right 6316LA, 40.0 - 100.0 cm**



40.0	6316LA-040
50.0	6316LA-050
60.0	6316LA-160
70.0	6316LA-070
80.0	6316LA-080
90.0	6316LA-090
100.0	6316LA-100

**Plus module Right 6306LA, 110.0 - 180.0 cm**

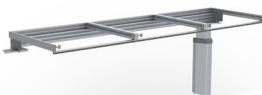

110.0	6306LA-100
120.0	6306LA-120
130.0	6306LA-130
140.0	6306LA-140
150.0	6306LA-150
160.0	6306LA-160
170.0	6306LA-170
180.0	6306LA-180

**Plus module Right 6316LA, 110.0 - 180.0 cm**



110.0	6316LA-110
120.0	6316LA-120
130.0	6316LA-130
140.0	6316LA-140
150.0	6316LA-150
160.0	6316LA-160
170.0	6316LA-170
180.0	6316LA-180

**Plus module Right 6306LA, 190.0 - 240.0 cm**

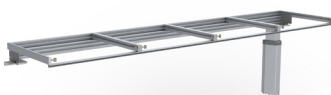











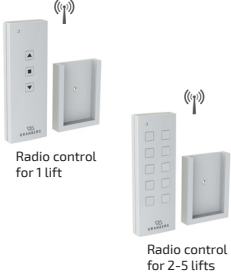

190.0	6306LA-190
200.0	6306LA-200
210.0	6306LA-210
220.0	6306LA-220
230.0	6306LA-230
240.0	6306LA-240

**Plus module Right 6316LA, 190.0 - 240.0 cm**

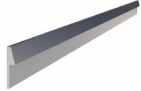

190.0	6316LA-190
200.0	6316LA-200
210.0	6316LA-210
220.0	6316LA-220
230.0	6316LA-230
240.0	6316LA-240

 <p><b>Control button, Mini</b> Wired, for recessed mounting Diameter: 20 mm</p>	<p>61318</p>	 <p><b>Safety strip</b> Used if pinch protection is desired on the gable end (by an open side). Length: 370 mm Height: 10 mm</p>	<p>61430</p>
 <p><b>Radio control - Hand control</b> Dimensions: 38 x 110 x 10 mm</p> <p>For one lift 61385 For two lifts 61387 For three lifts 61388 For four lifts 61389 For five lifts 61390</p> <p>Radio control for 1 lift Radio control for 2-5 lifts</p>		 <p><b>Safety panel, short end</b> Used when the worktop lift's underside passes over adjoining interior fittings. Height: 263 mm, Depth: 400 mm <b>For a worktop lift with cover panels</b></p> <p>Left 61442 Right 61443</p>	
 <p><b>Safety lock</b> Prevents unauthorised use. Dimensions: 23 x 9 mm</p>	<p>61360</p>	 <p><b>Safety panel, short end</b> Used when the worktop lift's underside passes over adjoining furnishings. Height: 263 mm, Depth: 545 mm <b>For a worktop lift without cover panels</b></p> <p>Left 61444 Right 61445</p>	
 <p><b>Front, white-lacquered aluminium</b> Replace xxx with cm when ordering. Example, 385L-040-01 for 40.0 cm</p> <p>Lacquered aluminium, white RAL 9003 Height: 40 mm Optional length, 20.0-340.0 cm</p>	<p>385L-xxx-01</p>	 <p><b>Hob cover under worktop lift</b> Provides a smooth underside. Used under the hob.</p> <p>White-lacquered metal RAL 9003</p> <p>60.0 cm 6266-060 70.0 cm 6266-070 80.0 cm 6266-080 90.0 cm 6266-090 100.0 cm 6266-100</p>	
 <p><b>Front, anodised aluminium</b> Replace xxx with cm when ordering. Example, 385L-040-06 for 40.0 cm</p> <p>Anodised aluminium Height: 40 mm Optional length, 20.0-340.0 cm</p>	<p>385L-XXX-06</p>	 <p><b>Cover panels</b> Used to cover installations under the worktop.</p> <p>Length is adapted to worktop lift's length.</p> <p>12 mm white melamine, 2 pcs height 438 mm 2 pcs are required for lengths over 2400 mm</p>	<p>6260-240</p>
 <p><b>Fittings set for cover panels</b> Used to mount cover panels that conceal installations under the worktop.</p> <p>Colour: Alu-grey RAL 9006 2 pcs are required for lengths over 2400 mm</p>	<p>6260-005</p>	 <p><b>Rear edge trim in aluminium for top board</b> Mounted behind top board. Brushed aluminium Height above top board: 20 mm Thickness behind top board: 3 mm (per metre)</p>	
		 <p><b>Height-adjustment kit</b> Used to change stroke after installation. Contains programming box and memory adapter.</p>	<p>6943-06</p> <p>61400</p>

# BASELIFT Corner 6303 / 6313

Wall-mounted or floor-mounted motorised corner worktop lift, 90° front edge, 90° wall

BASELIFT Corner 6303/6313 is a motorised corner worktop lift with 90° front edge and 90° rear edge. Choose between wall-mounted or floor-mounted motors.

Under the worktop, space is left for the knees and legs. Installations under the worktop, (motors, water, sewers) can be concealed with telescopic cover panels which gives the kitchen a neat look.

The motors work steplessly and adjust the worktop quickly and quietly to the desired height. The lift is equipped with a reliable safety system that guarantees safe operation without any risk of pinching. The lift is prepared in the factory to facilitate easy installation.



Corner worktop lift with 90° front edge and rear edge provides good access to the work surfaces on the sides. Installations under the worktop are hidden by cover panels.



Inset sink and hob can be integrated into the worktop.



A drawer can be integrated with the worktop.



**Functions and advantages**

- Motorised corner worktop lift, 90° front edge, 90° wall
- Height-adjustable 70-100 cm above the floor (excl. top board)
- The frame depth is adjustable 56-59 cm to fit adjoining cabinet
- The upper part of the lifting system is delivered ready-mounted. The sides are pre-assembled and adjustable side-ways to suit the sink, hob and drawers
- The lifting system is adjustable at an angle to compensate for an inclined wall
- Integrated safety switch
- 10 cm free space under motors for electrical installation and piping. (Applies to wall-mounted model)
- Choose floor-mounted model if there is no stable wall

**Standard equipment**

- Factory-mounted aluminium system with movable and tiltable brackets
- Wall-mounted or floor-mounted motors
- Safety switch

**Recommended additional options**

- Control button
- Front
- Hose cover/cover panels
- Sink (Not 6303L/6313L)
- Drawer (not 6303L/6313L)
- Rear edge trim
- Top board
- Hob

**Useful information**

- Fittings for top board and fronts enclosed
- The top board's depth must be 15 mm shallower than adjoining top boards (to provide a gap for tiles and movement)
- Width of the top board = width of the lift
- Sinks with a maximum height of 120 mm can be integrated (Not 6303L/6313L)
- Electronics and motor system "Plug and Play"
- Width of front = width of lift - 4 mm  
Height of front: 6303H/6313H = 103 mm, 6303L/6313L = 40 mm  
Fittings enclosed
- Cover panels can hide installations under the worktop  
2 pcs, height 438 mm, thickness 12-20 mm

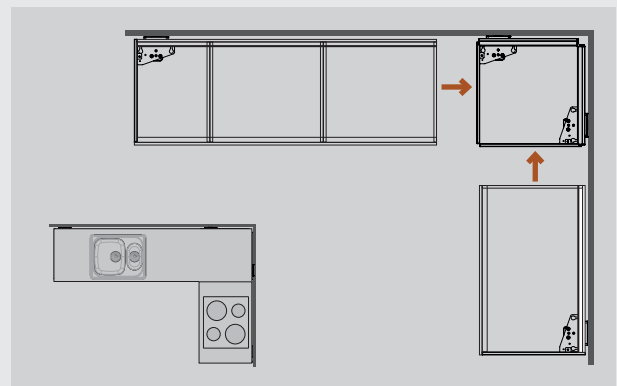

The corner module is equipped with two motors and can be used as one unit. Supplement with Plus modules to obtain the desired length on the left and right wings. Sink and hob can be positioned in the plus modules.

Specify the position of the drawers, sink and hob  
The worktop is prepared in the factory. Drawers are mounted and sides assembled to facilitate the final mounting on the spot.

**WALL-MOUNTED**

6303H



6303L



**FLOOR-MOUNTED**

6313H



6313L



**Specifications**

<b>Mounting</b>	Wall or floor
<b>Corner solution</b>	90° front edge, 90° wall
<b>Height adjustment</b>	Motorised, steplessly adjustable 300 mm (700-1000 mm excl. top board)
<b>Speed</b>	30 mm / sec.
<b>Manoeuvring</b>	Recessed mounted button or radio control
<b>Safety</b>	The safety strip is placed under the front edge of the worktop. If anything touches the safety strip, the lifting unit stops
<b>Electricity connection</b>	Plug for 230 V, max 5.0 A
<b>Plumbing connections</b>	Connection is made with flexible hoses
<b>Lifting power</b>	100 kg
<b>IP Class</b>	IP 20
<b>Frame depth</b>	560-590 mm from wall
<b>Front height</b>	40 or 103 mm
<b>Dimensions cover panels</b>	2 pcs, height 438 mm, thickness 12-20 mm
<b>Width top board</b>	Width = width of the lift
<b>Depth top board</b>	565-630 mm (15 mm shallower than worktops on fixed cabinets)
<b>Gap to the side to wall/adjoining cabinet</b>	5 mm
<b>Gap to wall (for tiling)</b>	15 mm
<b>Tiling</b>	From 700 mm above floor (alternatively all the way down to the floor)
<b>Delivery modules</b>	Ready-mounted worktop incl. safety switch, motors
<b>Fittings enclosed</b>	Bracket for fronts and top board
<b>Material specifications</b>	Aluminium frame
<b>Guarantee</b>	2 years
	<b>CE</b>

**Measurement data**

(mm)

**WALL-MOUNTED: 6303H/6303L**

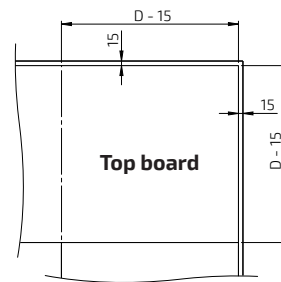
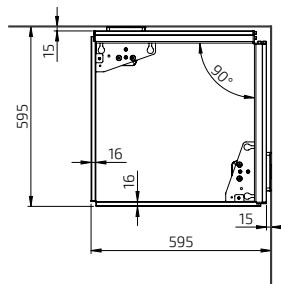
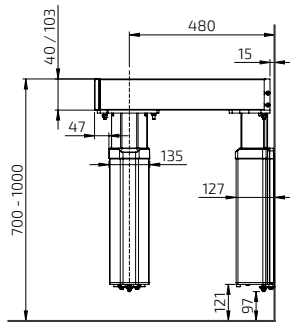

**D = Depth of top board on fixed cabinets**

**FLOOR-MOUNTED: 6313H / 6313L**

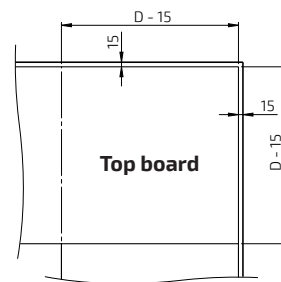
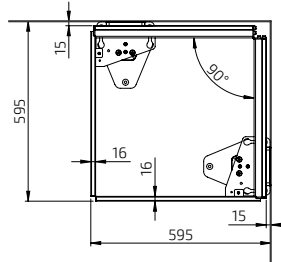
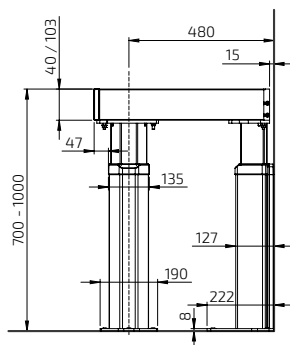

**D = Depth of top board on fixed cabinets**

**BASELIFT Corner 6303HA - Wall-mounted**

Lifting unit 59.5 x 59.5 cm  
 For 103 mm front  
 Frame depth 56.0 - 59.0 cm  
 2 motors  
 Safety switch

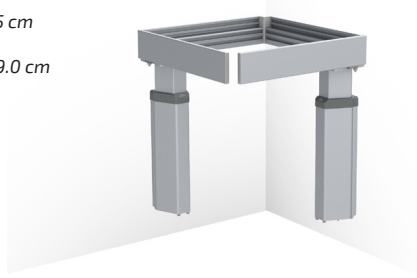

**BASELIFT Corner 6313HA - Floor-mounted**

Lifting unit 59.5 x 59.5 cm  
 For 103 mm front  
 Frame depth 56.0 - 59.0 cm  
 2 motors  
 Safety switch

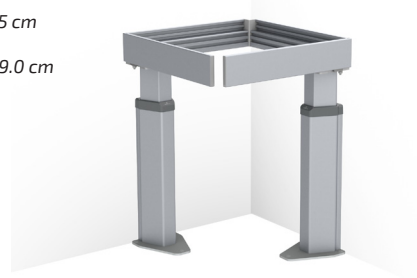

	Width (cm)	Art. no.
	59.5	6303HA-595

	Width (cm)	Art. no.
	59.5	6313HA-595

**Plus module Left 6305HA, 40.0-100.0 cm**



40.0	6305HA-040
50.0	6305HA-050
60.0	6305HA-060
70.0	6305HA-070
80.0	6305HA-080
90.0	6305HA-090
100.0	6305HA-100

**Plus module Left 6315HA, 40.0 - 100.0 cm**



40.0	6315HA-040
50.0	6315HA-150
60.0	6315HA-060
70.0	6315HA-070
80.0	6315HA-080
90.0	6315HA-090
100.0	6315HA-100

**Plus module Left 6305HA, 110.0-180.0 cm**



110.0	6305HA-110
120.0	6305HA-120
130.0	6305HA-130
140.0	6305HA-140
150.0	6305HA-150
160.0	6305HA-160
170.0	6305HA-170
180.0	6305HA-180

**Plus module Left 6315HA, 110.0 - 180.0 cm**



110.0	6315HA-110
120.0	6315HA-120
130.0	6315HA-130
140.0	6315HA-140
150.0	6315HA-150
160.0	6315HA-160
170.0	6315HA-170
180.0	6315HA-180

**Plus module Left 6305HA, 190.0-240.0 cm**



190.0	6305HA-190
200.0	6305HA-200
210.0	6305HA-210
220.0	6305HA-220
230.0	6305HA-230
240.0	6305HA-240

**Plus module Left 6315HA, 190.0 - 240.0 cm**



190.0	6315HA-190
200.0	6315HA-200
210.0	6315HA-210
220.0	6315HA-220
230.0	6315HA-230
240.0	6315HA-240

**Plus module Right 6306HA, 40.0-100.0 cm**



40.0	6306HA-040
50.0	6306HA-050
60.0	6306HA-060
70.0	6306HA-070
80.0	6306HA-080
90.0	6306HA-090
100.0	6306HA-100

**Plus module Right 6316HA, 40.0 - 100.0 cm**



40.0	6316HA-040
50.0	6316HA-050
60.0	6316HA-160
70.0	6316HA-070
80.0	6316HA-080
90.0	6316HA-090
100.0	6316HA-100

**Plus module Right 6306HA, 110.0 - 180.0 cm**



110.0	6306HA-110
120.0	6306HA-120
130.0	6306HA-130
140.0	6306HA-140
150.0	6306HA-150
160.0	6306HA-160
170.0	6306HA-170
180.0	6306HA-180

**Plus module Right 6316HA, 110.0 - 180.0 cm**



110.0	6316HA-110
120.0	6316HA-120
130.0	6316HA-130
140.0	6316HA-140
150.0	6316HA-150
160.0	6316HA-160
170.0	6316HA-170
180.0	6316HA-180

**Plus module Right 6306HA, 190.0 - 180.0 cm**













190.0	6306HA-190
200.0	6306HA-200
210.0	6306HA-210
220.0	6306HA-220
230.0	6306HA-230
240.0	6306HA-240









**Plus module Right 6316HA, 190.0 - 240.0 cm**



190.0	6316HA-190
200.0	6316HA-200
210.0	6316HA-210
220.0	6316HA-220
230.0	6316HA-230
240.0	6316HA-240

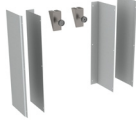
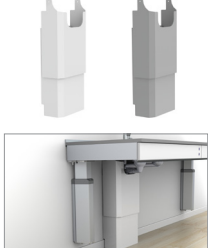
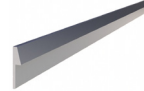

	<p><b>Control button in ALU-design</b> Wired, for recessed mounting Dimensions: 82 x 82 x 17 mm</p>	61320
	<p><b>Control button, Mini</b> Wired, for recessed mounting Diameter: 20 mm</p>	61318
	<p><b>Radio control - Hand control</b> Dimensions: 38 x 110 x 10 mm</p>	For one lift
		For two lifts
		For three lifts
		For four lifts
		For five lifts
	<p><b>Multi-compartment frame, ALU-design</b> Collects power socket, power switch or control buttons in a multi-compartment frame.</p>	
	Two-compartment frame: 153 x 82 x 9 mm	61352
	Three-compartment frame: 225 x 82 x 9 mm	61353
	<p><b>Socket, ALU-design</b> Earthed socket 230 V with flap cover. Dimensions: 82 x 82 x 17 mm Only Europe</p>	61330
	<p><b>Power switch, ALU-design</b> For lighting, for example. The button has a sign for optional marking. Dimensions: 82 x 82 x 17 mm</p>	61331
	<p><b>Safety lock</b> Prevents unauthorised use. Dimensions: 23 x 9 mm</p>	61360
	<p><b>Front, white-lacquered aluminium</b> Replace xxx with cm when ordering. Example, 385H-040-01 for 40.0 cm</p>	
	Lacquered aluminium, white RAL 9003 Height: 103 mm Optional length, 20.0-340.0 cm	385H-xxx-01
	<p><b>Front, anodised aluminium</b> Replace xxx with cm when ordering. Example, 385H-040-06 for 40.0 cm</p>	
	Anodised aluminium Height: 103 mm Optional length, 20.0-340.0 cm	385H-xxx-06
	<p><b>Integrated drawer with full extension and soft-close or push-to-open function</b> Depth: 470 mm, height: 85 mm Colour: Anthracite (RAL 9004)</p>	
	30.0 cm	465H-030
	40.0 cm	465H-040
	50.0 cm	465H-050
	60.0 cm	465H-060
	80.0 cm	465H-080
	30.0 cm - Push-to-open function	466H-030
	40.0 cm - Push-to-open function	466H-040
	50.0 cm - Push-to-open function	466H-050
	60.0 cm - Push-to-open function	466H-060
	80.0 cm - Push-to-open function	466H-080

	<p><b>Cutlery compartment</b></p>	
	Fits 30.0 cm wide drawer	463-030
	Fits 40.0 cm wide drawer	463-040
	Fits 50.0 cm wide drawer	463-050
	Fits 60.0 cm wide drawer	463-060
	Fits 80.0 cm wide drawer	463-080
	<p><b>Safety strip</b> Used if pinch protection is desired on the gable end (by an open side). Length: 370 mm, Height: 10 mm</p>	61430
	<p><b>Safety panel, short end</b> Used when the worktop lift's underside passes over adjoining furnishings. Height: 263 - 800 mm, Depth: 400 mm</p>	
	<b>For a worktop lift with cover panels</b>	
	Left	61442
	Right	61443
	<p><b>Safety panel, short end</b> Used when the worktop lift's underside passes over adjoining furnishings. Height: 263 - 800 mm, Depth: 545 mm</p>	
	<b>For a worktop lift without cover panels</b>	
	Left	61444
	Right	61445
	<p><b>Hob cover under worktop lift</b> Provides a smooth underside. Used under the hob.</p>	
	White-lacquered metal RAL 9003	
	60.0 cm	6266-060
	70.0 cm	6266-070
	80.0 cm	6266-080
	90.0 cm	6266-090
	100.0 cm	6266-100
	<p><b>Cover panels</b> Used to cover installations under the worktop.</p>	
	12 mm white melamine, 2 pcs height 438 mm	
	2 pcs are required for lengths over 2400 mm	6260-240
	<p><b>Fittings set for cover panels</b> Used to mount cover panels that conceal installations under the worktop.</p>	
	Colour: Alu-grey RAL 9006	
	2 pcs are required for lengths over 2400 mm	6260-005
	<p><b>Hose cover</b> The hose cover is mounted anywhere under the worktop, (next to motors, if applicable) to provide a neat coverage of hoses when the cover panels are not in use. Fittings are included.</p>	
	Width: 410 mm, Depth: 200 mm	
	White plastic	61504-01
	Grey plastic	61504-06
	<p><b>Rear edge trim in aluminium for top board</b> Mounted behind top board. Brushed aluminium Height above top board: 20 mm Thickness behind top board: 3 mm (per metre)</p>	6943-06
	<p><b>Height-adjustment kit</b> Used to change stroke after installation. Contains programming box and memory adapter.</p>	61400

**BASELIFT Corner 6303LA - Wall-mounted**

Lifting unit 59.5 x 59.5 cm  
 For 40 mm front  
 Frame depth 56.0 - 59.0 cm  
 2 motors  
 Safety switch



**BASELIFT Corner 6313LA - Floor-mounted**

Lifting unit 59.5 x 59.5 cm  
 For 40 mm front  
 Frame depth 56.0 - 59.0 cm  
 2 motors  
 Safety switch





	Width (cm)	Art. no.
	59.5	6303LA-595

	Width (cm)	Art. no.
	59.5	6313LA-595

Plus module Left 6305LA, 40.0-100.0 cm	Width (cm)	Art. no.
	40.0	6305LA-040
	50.0	6305LA-050
	60.0	6305LA-060
	70.0	6305LA-070
	80.0	6305LA-080
	90.0	6305LA-090
	100.0	6305LA-100

Plus module Left 6315LA, 40.0 - 100.0 cm	Width (cm)	Art. no.
	40.0	6315LA-040
	50.0	6315LA-150
	60.0	6315LA-060
	70.0	6315LA-070
	80.0	6315LA-080
	90.0	6315LA-090
	100.0	6315LA-100

Plus module Left 6305LA, 110.0-180.0 cm	Width (cm)	Art. no.
	110.0	6305LA-110
	120.0	6305LA-120
	130.0	6305LA-130
	140.0	6305LA-140
	150.0	6305LA-150
	160.0	6305LA-160
	170.0	6305LA-170
	180.0	6305LA-180

Plus module Left 6315LA, 110.0 - 180.0 cm	Width (cm)	Art. no.
	110.0	6315LA-110
	120.0	6315LA-120
	130.0	6315LA-130
	140.0	6315LA-140
	150.0	6315LA-150
	160.0	6315LA-160
	170.0	6315LA-170
	180.0	6315LA-180

Plus module Left 6305LA, 190.0-240.0 cm	Width (cm)	Art. no.
	190.0	6305LA-190
	200.0	6305LA-200
	210.0	6305LA-210
	220.0	6305LA-220
	230.0	6305LA-230
	240.0	6305LA-240

Plus module Left 6315LA, 190.0 - 240.0 cm	Width (cm)	Art. no.
	190.0	6315LA-190
	200.0	6315LA-200
	210.0	6315LA-210
	220.0	6315LA-220
	230.0	6315LA-230
	240.0	6315LA-240

Plus module Right 6306LA, 40.0 - 100.0 cm	Width (cm)	Art. no.
	40.0	6306LA-040
	50.0	6306LA-050
	60.0	6306LA-060
	70.0	6306LA-070
	80.0	6306LA-080
	90.0	6306LA-090
	100.0	6306LA-100













Plus module Right 6316LA, 40.0 - 100.0 cm	Width (cm)	Art. no.
	40.0	6316LA-040
	50.0	6316LA-050
	60.0	6316LA-160
	70.0	6316LA-070
	80.0	6316LA-080
	90.0	6316LA-090
	100.0	6316LA-100

Plus module Right 6306LA, 110.0 - 180.0 cm	Width (cm)	Art. no.
	110.0	6306LA-100
	120.0	6306LA-120
	130.0	6306LA-130
	140.0	6306LA-140
	150.0	6306LA-150
	160.0	6306LA-160
	170.0	6306LA-170
	180.0	6306LA-180

Plus module Right 6316LA, 110.0 - 180.0 cm	Width (cm)	Art. no.
	110.0	6316LA-110
	120.0	6316LA-120
	130.0	6316LA-130
	140.0	6316LA-140
	150.0	6316LA-150
	160.0	6316LA-160
	170.0	6316LA-170
	180.0	6316LA-180

Plus module Right 6306LA, 190.0 - 240.0 cm	Width (cm)	Art. no.
	190.0	6306LA-190
	200.0	6306LA-200
	210.0	6306LA-210
	220.0	6306LA-220
	230.0	6306LA-230
	240.0	6306LA-240

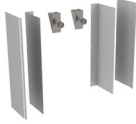
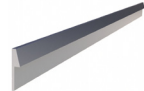
Plus module Right 6316LA, 190.0 - 240.0 cm	Width (cm)	Art. no.
	190.0	6316LA-190
	200.0	6316LA-200
	210.0	6316LA-210
	220.0	6316LA-220
	230.0	6316LA-230
	240.0	6316LA-240

	<p><b>Control button, Mini</b></p> <p>Wired, for recessed mounting Diameter: 20 mm</p> <p>61318</p>		<p><b>Safety strip</b></p> <p>Used if pinch protection is desired on the gable end (by an open side). Length: 370 mm Height: 10 mm</p> <p>61430</p>
 <p>Radio control for 1 lift</p>  <p>Radio control for 2-5 lifts</p>	<p><b>Radio control - Hand control</b> Dimensions: 38 x 110 x 10 mm</p> <p>For one lift 61385</p> <p>For two lifts 61387</p> <p>For three lifts 61388</p> <p>For four lifts 61389</p> <p>For five lifts 61390</p>		<p><b>Safety panel, short end</b> Used when the worktop lift's underside passes over adjoining interior fittings. Height: 263 mm, Depth: 400 mm</p> <p><b>For a worktop lift with cover panels</b></p> <p>Left 61442</p> <p>Right 61443</p>
	<p><b>Safety lock</b> Prevents unauthorised use. Dimensions: 23 x 9 mm</p> <p>61360</p>		<p><b>Safety panel, short end</b> Used when the worktop lift's underside passes over adjoining furnishings. Height: 263 mm, Depth: 545 mm</p> <p><b>For a worktop lift without cover panels</b></p> <p>Left 61444</p> <p>Right 61445</p>
	<p><b>Front, white-lacquered aluminium</b></p> <p>Replace xxx with cm when ordering. Example, 385L-040-01 for 40.0 cm</p> <p>Lacquered aluminium, white RAL 9003 Height: 40 mm</p> <p>Optional length, 20.0-340.0 cm 385L-xxx-01</p>		<p><b>Hob cover under worktop lift</b></p> <p>Provides a smooth underside. Used under the hob.</p> <p>White-lacquered metal RAL 9003</p> <p>60.0 cm 6266-060</p> <p>70.0 cm 6266-070</p> <p>80.0 cm 6266-080</p> <p>90.0 cm 6266-090</p> <p>100.0 cm 6266-100</p>
	<p><b>Front, anodised aluminium</b></p> <p>Replace xxx with cm when ordering. Example, 385L-040-06 for 40.0 cm</p> <p>Anodised aluminium Height: 40 mm</p> <p>Optional length, 20.0-340.0 cm 385L-XXX-06</p>		<p><b>Cover panels</b> Used to cover installations under the worktop.</p> <p>Length is adapted to worktop lift's length.</p> <p>12 mm white melamine, 2 pcs height 438 mm</p> <p>2 pcs are required for lengths over 2400 mm 6260-240</p>
			<p><b>Fittings set for cover panels</b> Used to mount cover panels that conceal installations under the worktop.</p> <p>Colour: Alu-grey RAL 9006</p> <p>2 pcs are required for lengths over 2400 mm 6260-005</p>
			<p><b>Rear edge trim in aluminium for top board</b> Mounted behind top board. Brushed aluminium Height above top board: 20 mm Thickness behind top board: 3 mm (per metre) 6943-06</p>
			<p><b>Height-adjustment kit</b> Used to change stroke after installation. Contains programming box and memory adapter.</p> <p>61400</p>

# SIDELIFT 6400

Floor-mounted, motorised, straight worktop lift with side motors

SIDELIFT 6400 is a straight, motorised worktop lift. Cabinets can be hung under the entire lift or under certain sections. Powerful motors (400 kg lifting power) are located on the short sides.

The motors work steplessly and adjust the worktop quickly and quietly to the desired height. The lift is equipped with a reliable safety system that guarantees safe operation without any risk of pinching. The lift is prepared in the factory to facilitate easy installation.



SIDELIFT creates an ergonomic kitchen worktop which everyone can use comfortably. The motors take up minimal space and there is ample room for storage in the hanging cabinets.



If needs change, the cabinets can easily be removed to provide space for work done when sitting down. The cabinets can be re-mounted just as easily.

## SIDELIFT 6400



### Functions and advantages

- Motorised, straight worktop lift with side motors
- Cabinets can be hung under the entire worktop or under certain parts
- Height-adjustable 70-100 cm above the floor (excl. top board)
- 400 kg lifting power
- Safety switch under cabinets and where there are spaces for knees
- Control button, Mini located in motor units

### Standard equipment

- Factory-mounted aluminium system
- Floor-mounted motors
- Control button

### Recommended additional options

- Hanging cabinets
- Front
- Safety plates (under hanging cabinets)
- Top board
- Sink
- Hob

### Useful information

- Fittings for top board enclosed
- Width of the top board = width of the lift
- The top board's depth must be 15 mm shallower than adjoining top boards (to provide a gap for tiles and movement)
- Sink bowls with a maximum height of 120 mm can be integrated
- Electronics and motor system "Plug and Play"
- Width of front = width of lift - 94 mm  
Height of front = 103 mm  
Fittings enclosed
- Cover panels can hide installations under the worktop  
Width = width of lift - 410 mm  
2 pcs height 438 mm, thickness 12-20 mm

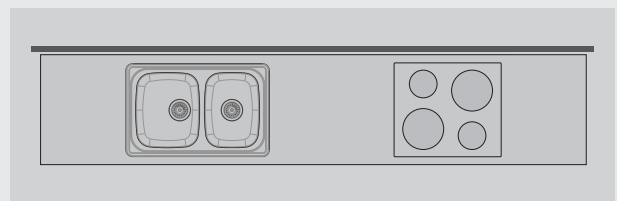

#### Specify the position of cabinets, sink and hob

The worktop is prepared in the factory to facilitate final assembly on site.



### Specifications

<b>Mounting</b>	Floor
<b>Height adjustment</b>	Motorised, steplessly adjustable 300 mm (700-1000 mm excl. top board)
<b>Speed</b>	20 mm / sec.
<b>Manoeuvring</b>	Control button, Mini is located in the motor units (left and right side)
<b>Safety</b>	There are safety switches under the cabinet and under the front in spaces for knees. The function of the safety switch is to stop the movement if it comes into contact with any object.
<b>Electricity connection</b>	Plug for 230 V, max 5,0 A
<b>Plumbing connections</b>	Connection is made with flexible hoses
<b>Lifting power</b>	400 kg
<b>IP Class</b>	IP 20
<b>Frame depth</b>	561 mm from wall
<b>Front height</b>	103 mm
<b>Dimensions cover panels</b>	Width = Width of lift -410 mm 2 pcs Height 438 mm Thickness 12 mm
<b>Width top board</b>	Width = width of the lift
<b>Depth top board</b>	15 mm shallower than worktops on fixed cabinets
<b>Gap to the side to wall/adjoining cabinet</b>	5 mm
<b>Gap to wall (for tiling)</b>	15 mm
<b>Tiling</b>	From 700 mm above floor (alternatively all the way down to the floor)
<b>Delivery modules</b>	1 package with motor units. 1 package with length-dependent beams
<b>Material specifications</b>	Motor units in lacquered steel (S235JRG2). Aluminium beams
<b>Guarantee</b>	2 years CE

### Measurement data

(mm)

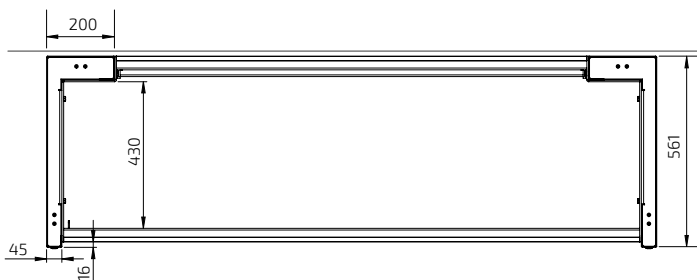
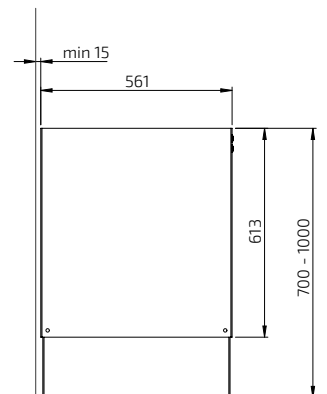
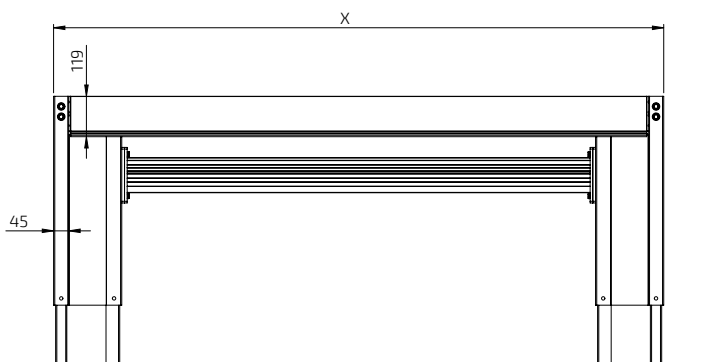

## SIDELIFT 6400H



With a SIDELIFT in your kitchen, the kitchen of the future is already here! An ergonomic kitchen worktop with generous storage space that can easily be height-adjusted.



If your needs change, the cabinets can easily be removed to provide space for work done when sitting down. The cabinets can be re-mounted just as easily.



Safety systems, in the form of safety plates under cabinets and safety strips where there are spaces for knees, stop all movement if any object comes in contact with the switches.



Inset sink with shallow sink bowl and hob can be integrated.



The hanging cabinets are equipped with two fully-extendable, soft-close drawers.



Hanging cabinets with waste sorting bins are available in widths 40-80 cm.



**SIDELIFT 6400H**

- White RAL 9003
- Incl. control button Mini in the motor units (left and right side)
- Supplement with front that conceals the lifting frame



Width (cm)	Art. no.	Width (cm)	Art. no.
99.0	6400HA-099-01	219.0	6400HA-219-01
109.0	6400HA-109-01	229.0	6400HA-229-01
119.0	6400HA-119-01	239.0	6400HA-239-01
129.0	6400HA-129-01	249.0	6400HA-249-01
139.0	6400HA-139-01	259.0	6400HA-259-01
149.0	6400HA-149-01	269.0	6400HA-269-01
159.0	6400HA-159-01	279.0	6400HA-279-01
169.0	6400HA-169-01	289.0	6400HA-289-01
179.0	6400HA-179-01	299.0	6400HA-299-01
189.0	6400HA-189-01	309.0	6400HA-309-01
199.0	6400HA-199-01	319.0	6400HA-319-01
209.0	6400HA-209-01	329.0	6400HA-329-01

**SIDELIFT 6400H**

- Anthracite RAL 9004
- Incl. manoeuvre button Mini in the motor units (left and right side)
- Supplement with front that conceals the lifting frame



99.0	6400HA-099-07	219.0	6400HA-219-07
109.0	6400HA-109-07	229.0	6400HA-229-07
119.0	6400HA-119-07	239.0	6400HA-239-07
129.0	6400HA-129-07	249.0	6400HA-249-07
139.0	6400HA-139-07	259.0	6400HA-259-07
149.0	6400HA-149-07	269.0	6400HA-269-07
159.0	6400HA-159-07	279.0	6400HA-279-07
169.0	6400HA-169-07	289.0	6400HA-289-07
179.0	6400HA-179-07	299.0	6400HA-299-07
189.0	6400HA-189-07	309.0	6400HA-309-07
199.0	6400HA-199-07	319.0	6400HA-319-07
209.0	6400HA-209-07	329.0	6400HA-329-07

**SIDELIFT 6400H**

- Black RAL 9005
- Incl. manoeuvre button Mini in the motor units (left and right side)
- Supplement with front panel that conceals the lifting frame



99.0	6400HA-099-10	219.0	6400HA-219-10
109.0	6400HA-109-10	229.0	6400HA-229-10
119.0	6400HA-119-10	239.0	6400HA-239-10
129.0	6400HA-129-10	249.0	6400HA-249-10
139.0	6400HA-139-10	259.0	6400HA-259-10
149.0	6400HA-149-10	269.0	6400HA-269-10
159.0	6400HA-159-10	279.0	6400HA-279-10
169.0	6400HA-169-10	289.0	6400HA-289-10
179.0	6400HA-179-10	299.0	6400HA-299-10
189.0	6400HA-189-10	309.0	6400HA-309-10
199.0	6400HA-199-10	319.0	6400HA-319-10
209.0	6400HA-209-10	329.0	6400HA-329-10

**Recommended accessories**

<p>Front that conceals the lifting frame</p>	<p>Hanging cabinets</p>
<p>Safety plates (under cabinets)</p>	<p>Cover panels</p>



**Hanging cabinet with drawers**  
The cabinet has a large drawer and a smaller inner drawer for cutlery and utensils.

Fully extendable with soft-close.  
Frame height 510 mm  
Frame depth: 470 mm

Frame in white melamine.  
White-lacquered door (NCS 0500-N)

30.0 cm	760-030-01
40.0 cm	760-040-01
50.0 cm	760-050-01
60.0 cm	760-060-01
70.0 cm	760-070-01
80.0 cm	760-080-01



**Mini cabinet on wheels with drawer and inner drawer, fully extendable with soft-close**

The cabinet is opened by pulling out the drawer.

Width: 400 mm  
Height: 574 mm  
Depth incl. grip handle: 495 mm

Top board in white compact laminate with integrated grip handle.

Frame in white melamine.  
White-lacquered door (NCS 0500-N)

770-040-01



**Hanging cabinet with waste sorting bins, 40 cm**

The cabinet is fitted with 2 waste bins. The upper part has an inner drawer for cutlery and utensils.

Fully extendable with soft-close.  
Frame height 510 mm  
Frame depth: 470 mm

Waste bins (litre):  
1 pc 17 litre, 1 pc 11 litre

Frame in white melamine.  
White-lacquered door (NCS 0500-N)

761-040-01



**Mini cabinet on wheels with waste sorting and inner drawer, fully extendable with soft-close**

The cabinet is opened by pulling out the drawer. The bottom with the waste bins is included.

Included bins:  
1 pc 11 liter 1 pc 17 liter

Width: 400 mm  
Height: 574 mm  
Depth incl. grip handle: 495 mm

Top board in white compact laminate with integrated grip handle.

Frame in white melamine.  
White-lacquered door (NCS 0500-N)

771-040-01

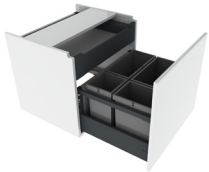

**Hanging cabinet with waste sorting bins, 60 cm**

The cabinet is fitted with 4 waste bins. The upper part has an inner drawer for cutlery and utensils.

Fully extendable with soft-close.  
Frame height 510 mm  
Frame depth: 470 mm

Waste bins (litre):  
1 pc 17 litre, 1 pc 11 litre, 1 pc 8 litre, 1 pc 5 litre

Frame in white melamine.  
White-lacquered door (NCS 0500-N)

761-060-01

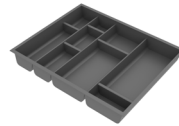

**Cutlery compartment for inner drawer**

Practical compartments that can be adapted to suit your needs.

Fits 30.0 cm wide inner drawer	460-030
Fits 40.0 cm wide inner drawer	460-040
Fits 50.0 cm wide inner drawer	460-050
Fits 60.0 cm wide inner drawer	460-060
Fits 70.0 cm wide inner drawer	460-070
Fits 80.0 cm wide inner drawer	460-080

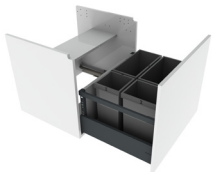

**Hanging cabinet under sink, 60 cm**  
The cabinet is fitted with 4 waste bins.

Fully extendable with soft-close.  
Frame height 510 mm  
Frame depth: 470 mm

Waste bins (litre):  
1 pc 17 litre, 1 pc 11 litre, 1 pc 8 litre, 1 pc 5 litre

Frame in white melamine.  
White-lacquered door (NCS 0500-N)

762-060-01



**Hanging cabinet under sink, 80 cm**  
The cabinet is fitted with 6 waste bins.

Fully extendable with soft-close.  
Frame height 510 mm  
Frame depth: 470 mm

Waste bins (litre):  
1 pc 17 litre, 1 pc 11 litre, 2 pcs 8 litre, 2 pcs 5 litre

Frame in white melamine.  
White-lacquered door (NCS 0500-N)

762-080-01



**Fittings for hanging cabinet**

One set per cabinet.

6250-001

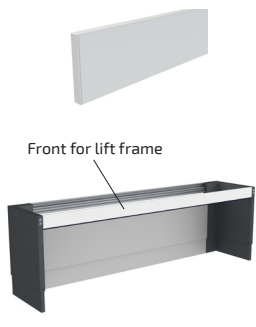
 <p>Front for lift frame</p>	<p><b>Front that conceals the lift frame</b></p> <p>Total length: Width of lift -94 mm</p> <p>Replace xxx with cm when ordering. For example, 385H-040-01 for 40.0 cm</p> <p>Height: 103 mm</p>								
	<table border="1"> <tr> <td>Lacquered aluminium, white RAL 9003</td> <td>385H-xxx-01</td> </tr> <tr> <td>Lacquered ALU, Anthracite RAL 9004</td> <td>385H-xxx-07</td> </tr> <tr> <td>Lacquered ALU, Black RAL 9004</td> <td>385H-xxx-10</td> </tr> <tr> <td>Anodised ALU</td> <td>385H-xxx-06</td> </tr> </table>	Lacquered aluminium, white RAL 9003	385H-xxx-01	Lacquered ALU, Anthracite RAL 9004	385H-xxx-07	Lacquered ALU, Black RAL 9004	385H-xxx-10	Anodised ALU	385H-xxx-06
Lacquered aluminium, white RAL 9003	385H-xxx-01								
Lacquered ALU, Anthracite RAL 9004	385H-xxx-07								
Lacquered ALU, Black RAL 9004	385H-xxx-10								
Anodised ALU	385H-xxx-06								

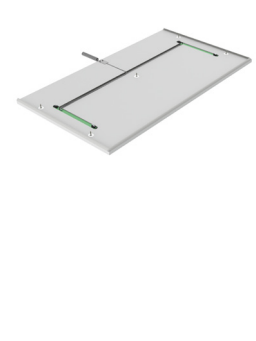
	<p><b>Safety plates SIDELIFT 6400</b></p> <p>The function of the safety plate is to stop the movement of the cabinet if the plate comes in contact with any object. Choose a plate that suits the width of the cabinet.</p> <p>Colour: White Thickness: 12 mm Depth: 466 mm</p>	
	30.0 cm width	6253-030-01
	40.0 cm width	6253-040-01
	50.0 cm width	6253-050-01
	60.0 cm width	6253-060-01
	70.0 cm width	6253-070-01
	80.0 cm width	6253-080-01

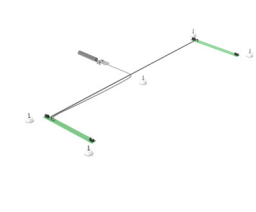
	<p><b>Safety package for safety plate of your own design</b></p> <p>The safety package contains micro-switches and cables for mounting on your own board. Instructions with milling dimensions enclosed.</p> <p>The dimensions of the board must be: Thickness: 12-16 mm Width: 400 - 800 mm Depth: 466 mm</p>	
		6253-00

	<p><b>Radio control - Hand control</b></p> <p>Dimensions: 38 x 110 x 10 mm</p>	
	For one lift	61385

	<p><b>Cover panels</b></p> <p>Used to cover installations under the worktop.</p> <p>12 mm white melamine 2 pcs height 438 mm</p>	
	2 panels are needed for lifts longer than 2490 mm	6262-240-01

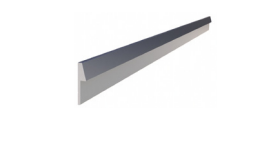
	<p><b>Rear edge trim in aluminium for top board</b> Mounted behind the top board. Brushed aluminium</p> <p>Height above top board: 20 mm Thickness behind top board: 3 mm</p>	
	(per metre)	6943-06

	<p><b>Height-adjustment kit</b></p> <p>Used to change stroke after installation. Contains programming box and memory adapter.</p>	
		61400

# MANULIFT 6380

Wall-mounted manually height-adjustable worktop unit

MANULIFT 6380H is a manually adjustable worktop unit.

Under the worktop, space is left for the knees and legs. Installations under the worktop, (brackets, water, sewers), can be concealed by telescopic cover panels which gives the kitchen a neat look.

The height is adjustable by 300 mm at 25 mm intervals. A built-in gas spring facilitates the adjustment. The lift is prepared in the factory to facilitate easy installation.

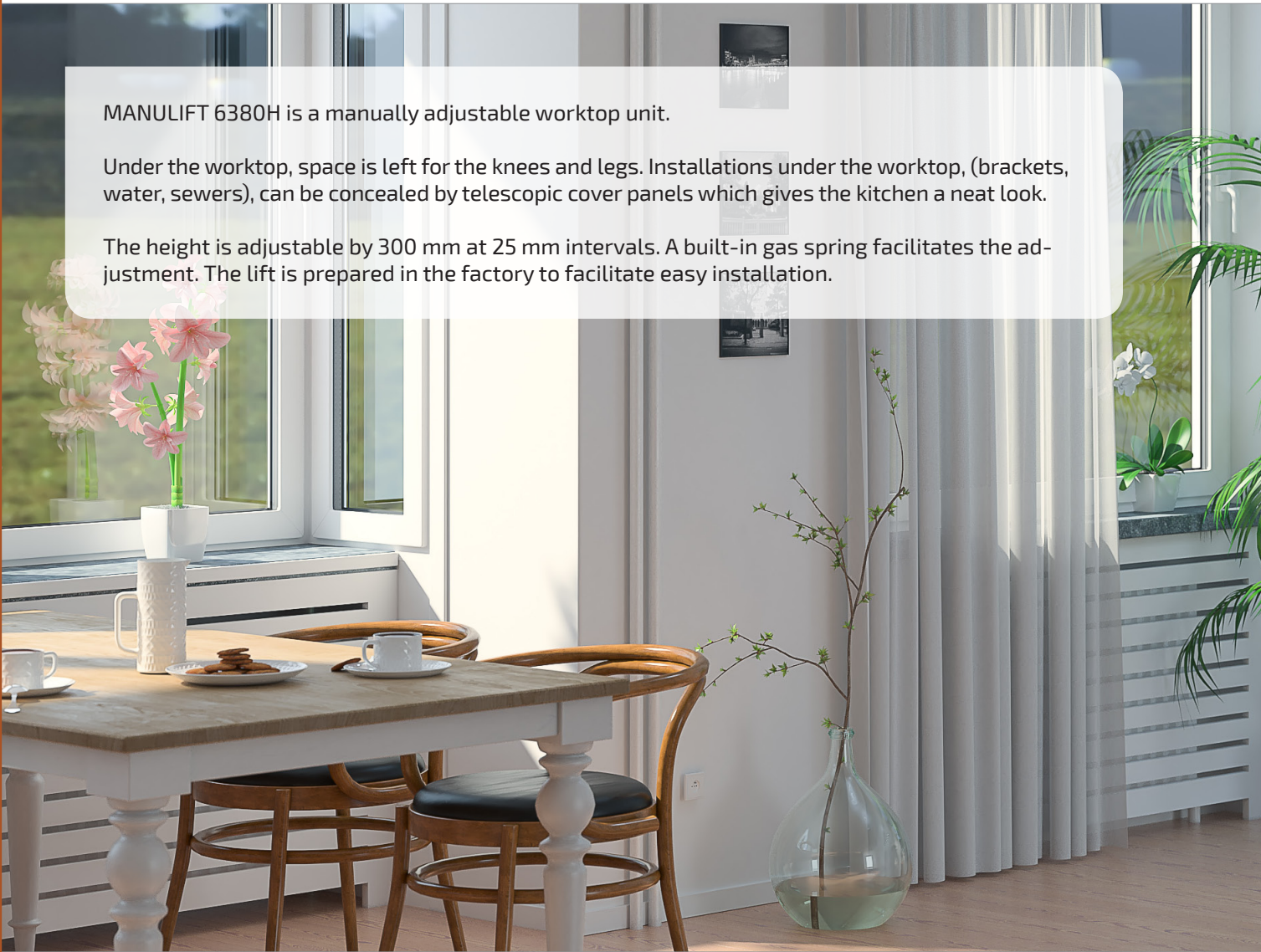

Sink, hob and drawer can be integrated into the worktop.



A built-in gas spring facilitates height adjustment:  
Pull out the locking pin, adjust the height, (the gas spring provides lifting help).  
Lock the position with the locking pin.



## Functions and advantages

- Manually height-adjustable worktop unit
- Height-adjustable 70-100 cm above the floor (excl. top board)
- A built-in gas spring facilitates height adjustment
- The frame depth is adjustable 56-59 cm to fit adjoining cabinet
- The upper part of the lifting system is delivered ready-mounted. The sides are pre-assembled and adjustable sideways to suit the sink, hob and drawers
- The lifting system is adjustable at an angle to compensate for an inclined wall
- 10 cm free space under the wall brackets for electrical installations and piping

## Standard equipment

- Factory-mounted aluminium system with movable and tiltable brackets
- Wall brackets with built-in gas spring

## Recommended additional options

- Front
- Rear edge trim
- Hose cover/cover panels
- Top board
- Sink (Not 6380L)
- Hob
- Drawer (not 6380L)

## Useful information

- Fittings for top board and fronts enclosed
- The top board's depth must be 15 mm shallower than adjoining top boards (to provide a gap for tiles and movement)
- Width of the top board = width of the lift
- Sink bowls with a maximum height of 120 mm can be integrated (Not 6380L)
- Width of front = width of lift - 4 mm  
Height of front: 6380H = 103 mm, 6380L = 40 mm  
Fittings enclosed
- Cover panels can hide installations under the worktop  
2 pcs width = width of lift - 10 mm, height 438 mm, thickness 12-20 mm

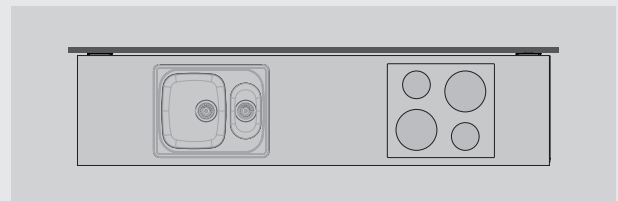

## Specify the location of drawers, sink and hob

The worktop is prepared in the factory. Drawers are mounted and sides assembled to facilitate the final mounting on the spot.

6380H



6380L



### Specifications

<b>Mounting</b>	Wall
<b>Height adjustment</b>	Manually adjustable by 300 mm in intervals of 25 mm (700-1000 mm excl. top board) A built-in gas spring facilitates height adjustment: Pull out the locking pin, adjust the height with the help of the gas spring. Lock the position with the locking pin.
<b>Plumbing connections</b>	Connection is made with flexible hoses
<b>Maximum load</b>	100 kg
<b>Frame depth</b>	560-590 mm from wall
<b>Front height</b>	40 or 103 mm
<b>Dimensions of cover panels</b>	2 pcs, width = width of the lift -10 mm, height 438 mm, thickness 12-20 mm
<b>Width of top board</b>	Width = width of the lift
<b>Depth of top board</b>	565-630 mm (15 mm shallower than worktops on fixed cabinets)
<b>Gap to the side to wall/adjoining cabinet</b>	5 mm
<b>Gap to wall (for tiling)</b>	15 mm
<b>Tiling</b>	From 700 mm above the floor (alternatively all the way down to the floor)
<b>Delivery modules</b>	Ready-mounted worktop incl. wall-mounted brackets
<b>Fittings enclosed</b>	Brackets for fronts and top board
<b>Material specifications</b>	Aluminium frame
<b>Guarantee</b>	2 years
	CE

### Measurement data

(mm)

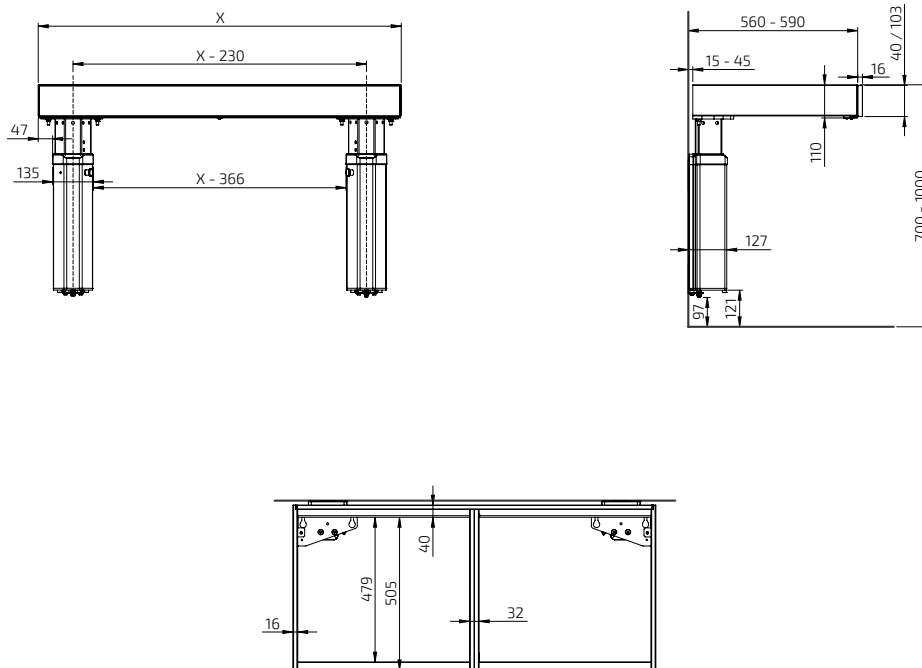

**MANULIFT 6380HA**

Wall-mounted worktop unit 59.0-100.0 cm width



Width (cm)	Art. no.
59.0	6380HA-059
60.0	6380HA-060
69.0	6380HA-069
70.0	6380HA-070
79.0	6380HA-079
80.0	6380HA-080
89.0	6380HA-089
90.0	6380HA-090
99.0	6380HA-099
100.0	6380HA-100

**MANULIFT 6380HA**

Wall-mounted worktop unit 109.0 - 180.0 cm width



109.0	6380HA-109
110.0	6380HA-110
119.0	6380HA-119
120.0	6380HA-120
129.0	6380HA-129
130.0	6380HA-130
139.0	6380HA-139
140.0	6380HA-140
149.0	6380HA-149
150.0	6380HA-150
159.0	6380HA-159
160.0	6380HA-160
169.0	6380HA-169
170.0	6380HA-170
179.0	6380HA-179
180.0	6380HA-180

**MANULIFT 6380HA**

Wall-mounted worktop unit 189.0 - 240.0 cm width





189.0	6380HA-189
190.0	6380HA-190
199.0	6380HA-199
200.0	6380HA-200
209.0	6380HA-209
210.0	6380HA-210
219.0	6380HA-219
220.0	6380HA-220
229.0	6380HA-229
230.0	6380HA-230
239.0	6380HA-239
240.0	6380HA-240





	<b>Multi-compartment frame, ALU-design</b> Collects power socket and power switch in a multi-compartment frame.	
	Two-compartment frame: 153 x 82 x 9 mm	61352
	Three-compartment frame: 225 x 82 x 9 mm	61353

	<b>Socket, ALU-design</b> Earthed socket 230 V with flap cover.	
	Dimensions: 82 x 82 x 17 mm Only Europe	61330

	<b>Power switch, ALU-design</b> For lighting, for example. The button has a sign for desired marking.	
	Dimensions: 82 x 82 x 17 mm	61331

	<b>Front, white-lacquered aluminium</b>  Replace xxx with cm when ordering. Example, 385H-040-01 for 40.0 cm	
	Lacquered aluminium, white RAL 9003 Height: 103 mm Optional length, 20.0-340.0 cm	385H-xxx-01

	<b>Front, anodised aluminium</b>  Replace xxx with cm when ordering. Example, 385H-040-06 for 40.0 cm	
	Anodised aluminium Height: 103 mm Optional length, 20.0-340.0 cm	385H-xxx-06

	<b>Integrated drawer with full extension and soft-close or push-to-open function</b>  Depth: 470 mm, height: 85 mm Colour: Anthracite (RAL 9004)	
	30.0 cm	465H-030
	40.0 cm	465H-040
	50.0 cm	465H-050
	60.0 cm	465H-060
	80.0 cm	465H-080
	30.0 cm - Push-to-open function	466H-030
	40.0 cm - Push-to-open function	466H-040
	50.0 cm - Push-to-open function	466H-050
	60.0 cm - Push-to-open function	466H-060
	80.0 cm - Push-to-open function	466H-080

	<b>Cutlery compartment</b>	
	Fits 30.0 cm wide drawer	463-030
	Fits 40.0 cm wide drawer	463-040
	Fits 50.0 cm wide drawer	463-050
	Fits 60.0 cm wide drawer	463-060
	Fits 80.0 cm wide drawer	463-080

	<b>Hob cover under worktop lift</b> Provides a smooth underside. Used under the hob.	
	White-lacquered metal RAL 9003	
	60.0 cm	6266-060
	70.0 cm	6266-070
	80.0 cm	6266-080
	100.0 cm	6266-100

	<b>Cover panels</b> Used to cover installations under the worktop.	
	12 mm white melamine, 2 pcs height 438 mm	6260-240

	<b>Fittings set for cover panels</b> Used to mount cover panels that conceal installations under the worktop.	
	Colour: Alu-grey RAL 9006	6260-005

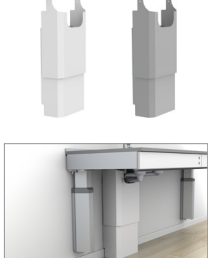
	<b>Hose cover</b> The hose cover is mounted anywhere under the worktop, (next to motors, if applicable) to provide a neat coverage of hoses when the cover panels are not in use. Fittings are included.	
	Width: 410 mm, Depth: 200 mm	
	White plastic	61504-01
	Grey plastic	61504-06

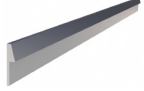
	<b>Rear edge trim in aluminium for top board</b> Mounted behind the top board.	
	Brushed aluminium Height above top board: 20 mm Thickness behind top board: 3 mm (per metre)	6943-06

**MANULIFT 6380LA**

Wall-mounted worktop unit 59.0-100.0 cm width



Width (cm)	Art. no.
59.0	6380LA-059
60.0	6380LA-060
69.0	6380LA-069
70.0	6380LA-070
79.0	6380LA-079
80.0	6380LA-080
89.0	6380LA-089
90.0	6380LA-090
99.0	6380LA-099
100.0	6380LA-100

**MANULIFT 6380LA**

Wall-mounted worktop unit 109.0 - 180.0 cm width







109.0	6380LA-109
110.0	6380LA-110
119.0	6380LA-119
120.0	6380LA-120
129.0	6380LA-129
130.0	6380LA-130
139.0	6380LA-139
140.0	6380LA-140
149.0	6380LA-149
150.0	6380LA-150
159.0	6380LA-159
160.0	6380LA-160
169.0	6380LA-169
170.0	6380LA-170
179.0	6380LA-179
180.0	6380LA-180

**MANULIFT 6380LA**

Wall-mounted worktop unit 189.0 - 240.0 cm width

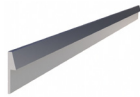

189.0	6380LA-189
190.0	6380LA-190
199.0	6380LA-199
200.0	6380LA-200
209.0	6380LA-209
210.0	6380LA-210
219.0	6380LA-219
220.0	6380LA-220
229.0	6380LA-229
230.0	6380LA-230
239.0	6380LA-239
240.0	6380LA-240

	<p><b>Front, white-lacquered aluminium</b></p> <p>Replace xxx with cm when ordering. For example, 385L-040-01 for 40.0 cm</p> <p>Lacquered aluminium, white RAL 9003 Height: 40 mm Optional length, 20.0-340.0 cm</p>	<p>385L-xxx-01</p>
	<p><b>Front, anodised aluminium</b></p> <p>Replace xxx with cm when ordering. For example, 385L-040-06 for 40.0 cm</p> <p>Anodised aluminium Height: 40 mm Optional length, 20.0-340.0 cm</p>	<p>385L-XXX-06</p>
	<p><b>Hob cover under worktop lift</b></p> <p>Provides a smooth underside. Used under the hob. White-lacquered metal RAL 9003</p> <p>60.0 cm</p> <p>70.0 cm</p> <p>80.0 cm</p> <p>90.0 cm</p> <p>100.0 cm</p>	<p>6266-060</p> <p>6266-070</p> <p>6266-080</p> <p>6266-090</p> <p>6266-100</p>
	<p><b>Cover panels</b></p> <p>Used to cover installations under the worktop.</p> <p>12 mm white melamine 2 pcs height 438 mm</p>	<p>6260-240</p>
	<p><b>Fittings set for cover panels</b></p> <p>Used to mount cover panels that conceal installations under the worktop.</p> <p>Colour: Alu-grey RAL 9006</p>	<p>6260-005</p>
	<p><b>Rear edge trim in aluminium for top board</b></p> <p>Mounted behind the top board. Brushed aluminium Height above top board: 20 mm Thickness behind top board: 3 mm (per metre)</p>	<p>6943-06</p>

# CENTERLIFT 960

Motorised kitchen island with space for knees

Both tall and short people work in the kitchen and everyone needs different working heights. Moreover, different kitchen chores require different working heights.

CENTERLIFT creates a kitchen in which everyone can work comfortably while also providing a natural hub in the kitchen where people can gather, on an ordinary weekday or on festive occasions.

The lifting system can be integrated with kitchens from any kitchen manufacturer.



The kitchen island can be designed to suit individual needs. Here, an inset sink with a shallow sink bowl has been integrated with the kitchen island.



The hob can be integrated with the kitchen island and thus becomes accessible from both a standing and sitting position.



## Functions and advantages

- Motorised kitchen island lift
- Height-adjustable 70-110 cm above floor (excl. top board)
- 200 kg lifting power
- The upper part of the lifting system is delivered ready-mounted. The sides are pre-assembled and adjustable side-ways to suit the sink and hob
- Integrated safety switch

## Standard equipment

- Factory-mounted aluminium system with movable brackets
- Floor-mounted motors
- Safety switch

## Recommended additional options

- Control button
- Top board
- Front
- Hob
- Sink

## Useful information

- Fittings for top board enclosed
- Sink bowls with a maximum height of 120 mm can be integrated
- Electronics and motor system "Plug and Play"
- The position of the motors is adjustable to the side (then screwed into the floor)

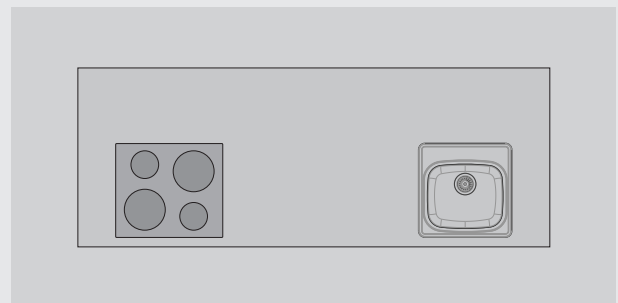

### Specify the location of sink and hob

The worktop is prepared in the factory. Dividers have been positioned to facilitate the final mounting on the spot.



### Specifications

<b>Mounting</b>	Floor
<b>Height adjustment</b>	Motorised, steplessly adjustable 400 mm (700-1100 mm excl. top board)
<b>Speed</b>	30 mm / sec.
<b>Manoeuvring</b>	Recessed mounted button or radio control
<b>Safety</b>	The safety strip is placed under the frame. If anything touches the safety strip, the lifting unit stops
<b>Electricity connection</b>	Plug for 230 V, max 5.0 A
<b>Plumbing connections</b>	Connection is made with flexible hoses
<b>Lifting power</b>	200 kg
<b>IP Class</b>	IP 20
<b>Frame depth incl. front</b>	580 / 780 / 980 / 1180 mm
<b>Frame depth for own front</b>	548 / 748 / 948 / 1148 mm
<b>Width of top board</b>	1200 / 1400 / 1600 / 1800 / 2000 / 2200 / 2400 / 2600 / 2800 mm
<b>Depth of top board</b>	600 / 800 / 1000 / 1200 mm
<b>Front height</b>	103 mm
<b>Delivery modules</b>	Ready-mounted worktop incl. safety switch, motors
<b>Fittings enclosed</b>	Brackets for fronts and top board
<b>Material specifications</b>	Aluminium frame
<b>Guarantee</b>	2 years
	CE

### Measurement data

(mm)

Width (X) Frame incl. front	Width (X) Frame for own front	Width Top board
1180 mm	1148 mm	1200 mm
1380 mm	1348 mm	1400 mm
1580 mm	1548 mm	1600 mm
1780 mm	1748 mm	1800 mm
1980 mm	1948 mm	2000 mm
2180 mm	2148 mm	2200 mm
2380 mm	2348 mm	2400 mm
2580 mm	2548 mm	2600 mm
2780 mm	2748 mm	2800 mm

Depth (Y) Frame incl. front	Depth (Y) Frame for own front	Depth Top board
580 mm	548 mm	600 mm
780 mm	748 mm	800 mm
980 mm	948 mm	1000 mm
1180 mm	1148 mm	1200 mm

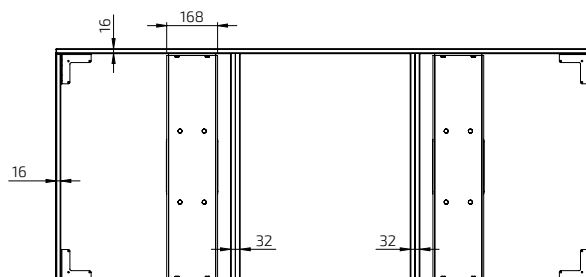
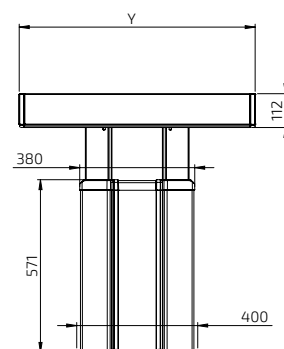
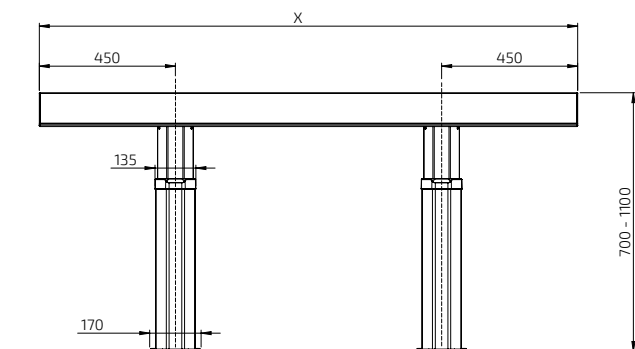

**CENTERLIFT 960HA**

-Depth 58.0 cm, white or anodised aluminium front  
 -Adjustability: 70.0-110.0 cm (40.0 cm)



For worktop (cm)	Width (cm)	Depth (cm)	Art. no White Alu. front	Art. no Anodised Alu. front
120.0 x 60.0 cm	118.0	58.0	960HA-120-01	960HA-120-06
140.0 x 60.0 cm	138.0	58.0	960HA-140-01	960HA-140-06
160.0 x 60.0 cm	158.0	58.0	960HA-160-01	960HA-160-06
180.0 x 60.0 cm	178.0	58.0	960HA-180-01	960HA-180-06
200.0 x 60.0 cm	198.0	58.0	960HA-200-01	960HA-200-06
220.0 x 60.0 cm	218.0	58.0	960HA-220-01	960HA-220-06
240.0 x 60.0 cm	238.0	58.0	960HA-240-01	960HA-240-06
260.0 x 60.0 cm	258.0	58.0	960HA-260-01	960HA-260-06
280.0 x 60.0 cm	278.0	58.0	960HA-280-01	960HA-280-06

**CENTERLIFT 960HC**

-Depth 78.0 cm, white or anodised aluminium front  
 -Adjustability: 70.0-110.0 cm (40.0 cm)



For worktop (cm)	Width (cm)	Depth (cm)	Art. no White Alu. front	Art. no Anodised Alu. front
120.0 x 80.0 cm	118.0	78.0	960HC-120-01	960HC-120-06
140.0 x 80.0 cm	138.0	78.0	960HC-140-01	960HC-140-06
160.0 x 80.0 cm	158.0	78.0	960HC-160-01	960HC-160-06
180.0 x 80.0 cm	178.0	78.0	960HC-180-01	960HC-180-06
200.0 x 80.0 cm	198.0	78.0	960HC-200-01	960HC-200-06
220.0 x 80.0 cm	218.0	78.0	960HC-220-01	960HC-200-06
240.0 x 80.0 cm	238.0	78.0	960HC-240-01	960HC-240-06
260.0 x 80.0 cm	258.0	78.0	960HC-260-01	960HC-260-06
280.0 x 80.0 cm	278.0	78.0	960HC-280-01	960HC-280-06

**CENTERLIFT 960HE**

-Depth 98.0 cm, white or anodised aluminium front  
 -Adjustability: 70.0-110.0 cm (40.0 cm)



For worktop (cm)	Width (cm)	Depth (cm)	Art. no White Alu. front	Art. no Anodised Alu. front
120.0 x 100.0 cm	118.0	98.0	960HE-120-01	960HE-120-06
140.0 x 100.0 cm	138.0	98.0	960HE-140-01	960HE-140-06
160.0 x 100.0 cm	158.0	98.0	960HE-160-01	960HE-160-06
180.0 x 100.0 cm	178.0	98.0	960HE-180-01	960HE-180-06
200.0 x 100.0 cm	198.0	98.0	960HE-200-01	960HE-200-06
220.0 x 100.0 cm	218.0	98.0	960HE-220-01	960HE-220-06
240.0 x 100.0 cm	238.0	98.0	960HE-240-01	960HE-240-06
260.0 x 100.0 cm	258.0	98.0	960HE-260-01	960HE-260-06
280.0 x 100.0 cm	278.0	98.0	960HE-280-01	960HE-280-06

**CENTERLIFT 960HF**

-Depth 118.0 cm, white or anodised aluminium front  
 -Adjustability: 70.0-110.0 cm (40.0 cm)



For worktop (cm)	Width (cm)	Depth (cm)	Art. no White Alu. front	Art. no Anodised Alu. front
120.0 x 120.0 cm	118.0	118.0	960HF-120-01	960HF-120-06
140.0 x 120.0 cm	138.0	118.0	960HF-140-01	960HF-140-06
160.0 x 120.0 cm	158.0	118.0	960HF-160-01	960HF-160-06
180.0 x 120.0 cm	178.0	118.0	960HF-180-01	960HF-180-06
200.0 x 120.0 cm	198.0	118.0	960HF-200-01	960HF-200-06
220.0 x 120.0 cm	218.0	118.0	960HF-220-01	960HF-220-06
240.0 x 120.0 cm	238.0	118.0	960HF-240-01	960HF-240-06
260.0 x 120.0 cm	258.0	118.0	960HF-260-01	960HF-260-06
280.0 x 120.0 cm	278.0	118.0	960HF-280-01	960HF-280-06



**CENTERLIFT 960HA - For own front**  
 - Depth 54.8 cm  
 - Adjustability: 70.0-110.0 cm (40.0 cm)



For worktop (cm)	Width (cm)	Depth (cm)	Art. no.
120.0 x 60.0 cm	114.8	54.8	960HA-120-00
140.0 x 60.0 cm	134.8	54.8	960HA-140-00
160.0 x 60.0 cm	154.8	54.8	960HA-160-00
180.0 x 60.0 cm	174.8	54.8	960HA-180-00
200.0 x 60.0 cm	194.8	54.8	960HA-200-00
220.0 x 60.0 cm	214.8	54.8	960HA-220-00
240.0 x 60.0 cm	234.8	54.8	960HA-240-00
260.0 x 60.0 cm	254.8	54.8	960HA-260-00
280.0 x 60.0 cm	274.8	54.8	960HA-280-00

**CENTERLIFT 960HC - For own front**  
 - Depth 74.8 cm  
 - Adjustability: 70.0-110.0 cm (40.0 cm)



For worktop (cm)	Width (cm)	Depth (cm)	Art. no.
120.0 x 80.0 cm	114.8	74.8	960HC-120-00
140.0 x 80.0 cm	134.8	74.8	960HC-140-00
160.0 x 80.0 cm	154.8	74.8	960HC-160-00
180.0 x 80.0 cm	174.8	74.8	960HC-180-00
200.0 x 80.0 cm	194.8	74.8	960HC-200-00
220.0 x 80.0 cm	214.8	74.8	960HC-200-00
240.0 x 80.0 cm	234.8	74.8	960HC-240-00
260.0 x 80.0 cm	254.8	74.8	960HC-260-00
280.0 x 80.0 cm	274.8	74.8	960HC-280-00

**CENTERLIFT 960HE - For own front**  
 - Depth 94.8 cm  
 - Adjustability: 70.0-110.0 cm (40.0 cm)



For worktop (cm)	Width (cm)	Depth (cm)	Art. no.
120.0 x 100.0 cm	114.8	94.8	960HE-120-00
140.0 x 100.0 cm	134.8	94.8	960HE-140-00
160.0 x 100.0 cm	154.8	94.8	960HE-160-00
180.0 x 100.0 cm	174.8	94.8	960HE-180-00
200.0 x 100.0 cm	194.8	94.8	960HE-200-00
220.0 x 100.0 cm	214.8	94.8	960HE-220-00
240.0 x 100.0 cm	234.8	94.8	960HE-240-00
260.0 x 100.0 cm	254.8	94.8	960HE-260-00
280.0 x 100.0 cm	274.8	94.8	960HE-280-00

**CENTERLIFT 960HF - For own front**  
 - Depth 114.8 cm  
 - Adjustability: 70.0-110.0 cm (40.0 cm)



For worktop (cm)	Width (cm)	Depth (cm)	Art. no.
120.0 x 120.0 cm	114.8	114.8	960HF-120-00
140.0 x 120.0 cm	134.8	114.8	960HF-140-00
160.0 x 120.0 cm	154.8	114.8	960HF-160-00
180.0 x 120.0 cm	174.8	114.8	960HF-180-00
200.0 x 120.0 cm	194.8	114.8	960HF-200-00
220.0 x 120.0 cm	214.8	114.8	960HF-220-00
240.0 x 120.0 cm	234.8	114.8	960HF-240-00
260.0 x 120.0 cm	254.8	114.8	960HF-260-00
280.0 x 120.0 cm	274.8	114.8	960HF-280-00



**Control button, Mini**  
 Wired, for recessed mounting  
 Diameter: 20 mm

61318



**Control button in ALU-design**  
 Wired, for recessed mounting  
 Dimensions: 82 x 82 x 17 mm

61320



**Radio control - Hand control**  
 Dimensions: 38 x 110 x 10 mm

61385



**Multi-compartment frame, ALU-design**  
 Collects power socket, power switch or control buttons in a multi-compartment frame.  
 Two-compartment frame: 153 x 82 x 9 mm  
 Three-compartment frame: 225 x 82 x 9 mm

61352

61353



**Socket, ALU-design**  
 Earthed socket 230 V with flap cover.  
 Dimensions: 82 x 82 x 17 mm  
 Only Europe

61330



**Power switch, ALU-design**  
 For lighting, for example. The button has a sign for desired marking.  
 Dimensions: 82 x 82 x 17 mm

61331



**Safety lock**  
 Prevents unauthorised use.  
 Dimensions: 23 x 9 mm

61360



**Hose cover**  
 Mounted under the worktop to provide a neat coverage of hoses.  
 Anodised aluminium  
 Fittings are included.  
 Width: 300 mm, Depth: 200 mm

61508-06

# CENTERLIFT 6490

Motorised kitchen island with hanging cabinets and space for knees

CENTERLIFT 6490 is a motorised kitchen island.

With cabinets on one side and open space on the other side, a height-adjustable work area is created with space for knees on one side and generous storage space on the other.

CENTERLIFT creates a kitchen in which everyone can work comfortably while also providing a natural place for people to gather in the kitchen on all occasions.

The lifting system can be integrated with kitchens from any kitchen manufacturer.



One side is open to provide space for knees for work done sitting down.



Inset sink with shallow sink bowl and hob can be integrated with the kitchen island.



Any height adjustment moves the cabinets as well, providing an ergonomic kitchen island with good storage space.



## Functions and advantages

- Motorised kitchen island lift for cabinets and the part with space for knees
- Height-adjustable 70-110 cm above floor (excl. top board)
- 400 kg lifting power
- Safety switch under storage cabinet and the part with space for knees

## Standard equipment

- Factory-mounted aluminium system
- Floor-mounted motors
- Control button
- Safety switch at the part with space for knees

## Recommended additional options

- Hanging cabinets
- Cover package
- Fronts
- Safety plates (under hanging cabinets)
- Top board
- Sink
- Hob

## Useful information

- Fittings for worktop and fronts are included
- Worktop width = lift width + thickness of side cover + desired protrusion
- Worktop depth = lift depth (1106 mm) + thickness of front cover + desired protrusion
- Electronics and motor system "Plug and Play"
- Cover panel can hide installations under the worktop on the side with space for knees  
1 pc, width = width of lift, height 510 mm, thickness 12-20 mm

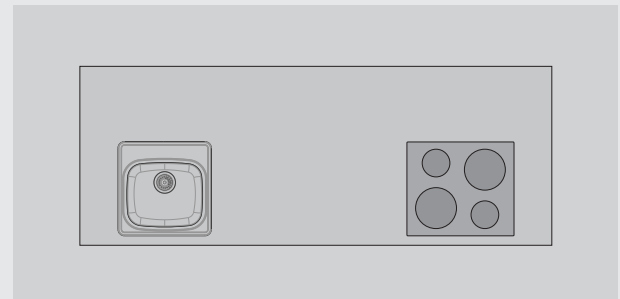

### Specify the location of drawers, sink and hob

The worktop is prepared in the factory to facilitate final assembly on site.

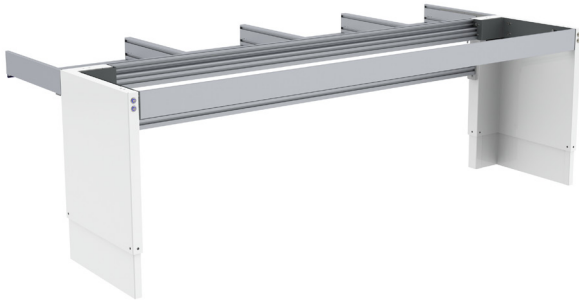

### Specifications

<b>Mounting</b>	Floor
<b>Height adjustment</b>	Motorised, steplessly adjustable 400 mm (700-1100 mm excl. top board)
<b>Speed</b>	20 mm / sec.
<b>Manoeuvring</b>	Recessed mounted buttons located in the motor units (left and right side)
<b>Safety</b>	Safety switches under the cabinet and under the front of spaces for knees. The function of the safety switch is to stop the movement if it comes in contact with any object.
<b>Electricity connection</b>	Plug for 230 V, max 5.0 A
<b>Plumbing connections</b>	Connection is made with flexible hoses
<b>Lifting power</b>	400 kg
<b>IP Class</b>	IP 20
<b>Frame depth</b>	1106 mm
<b>Front height of side with space for knees</b>	103 mm
<b>Dimensions of cover panel on the side with space for knees</b>	1 pc, width = width of lift, height 510 mm, thickness 12-20 mm
<b>Width of top board</b>	Width of lift + thickness of the side cover + Desired protrusion
<b>Depth of top board</b>	Depth of lift (1106 mm) + thickness of the front cover + Desired protrusion
<b>Delivery modules</b>	1 package with motor units. 1 package with length-dependent beams. 1 package with ready-mounted aluminium system for the part with space for knees
<b>Fittings enclosed</b>	Brackets for fronts and top board
<b>Material specifications</b>	Motor units in lacquered steel (S235JRG2). Aluminium beams Aluminium frame for the part with space for knees
<b>Guarantee</b>	2 years
	CE

### Measurement data

(mm)

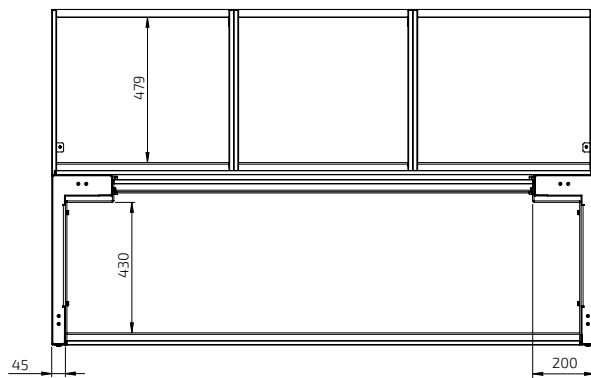
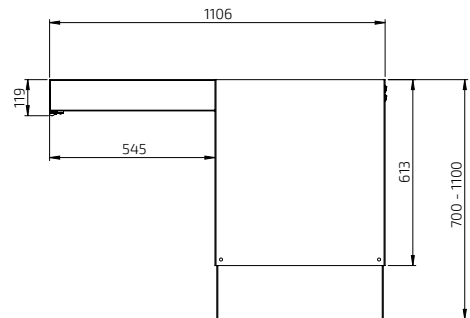
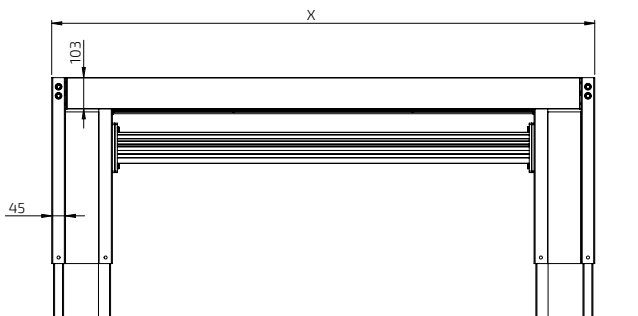

## CENTERLIFT 6490



Side with space for knees for work done when seated.



Cabinet side with generous storage space.



The cabinets are equipped with two fully-extendable, soft-close drawers.



The side with space for knees can be equipped with drawers.



Safety system in the form of safety plates under cabinets and safety strips under the part with space for knees stops the machinery if any object comes into contact with the switches.



Supplement with a mini cabinet on wheels for waste sorting.

**CENTERLIFT 6490**

-White RAL 9003

-Incl. control button Mini in the motor units (left and right side)

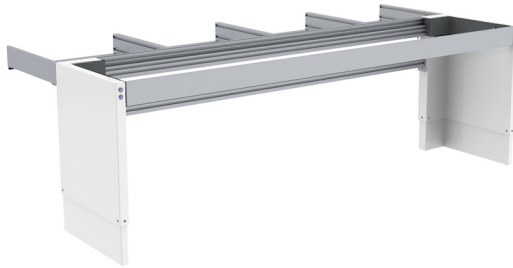

Width (cm)	Art. no.	Width (cm)	Art. no.
79.0	6490HA-079-01	209.0	6490HA-209-01
89.0	6490HA-089-01	219.0	6490HA-219-01
99.0	6490HA-099-01	229.0	6490HA-229-01
109.0	6490HA-109-01	239.0	6490HA-239-01
119.0	6490HA-119-01	249.0	6490HA-249-01
129.0	6490HA-129-01	259.0	6490HA-259-01
139.0	6490HA-139-01	269.0	6490HA-269-01
149.0	6490HA-149-01	279.0	6490HA-279-01
159.0	6490HA-159-01	289.0	6490HA-289-01
169.0	6490HA-169-01	299.0	6490HA-299-01
179.0	6490HA-179-01	309.0	6490HA-309-01
189.0	6490HA-189-01	319.0	6490HA-319-01
199.0	6490HA-199-01	329.0	6490HA-329-01

**CENTERLIFT 6490**

- Anthracite RAL 9004

- Incl. control button Mini in the motor units (left and right side)

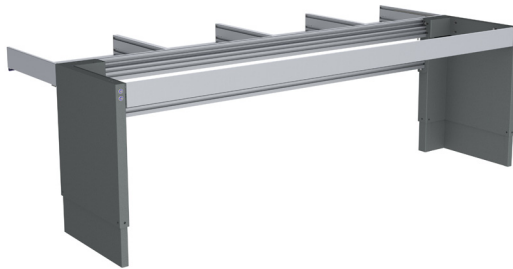

79.0	6490HA-079-07	209.0	6490HA-209-07
89.0	6490HA-089-07	219.0	6490HA-219-07
99.0	6490HA-099-07	229.0	6490HA-229-07
109.0	6490HA-109-07	239.0	6490HA-239-07
119.0	6490HA-119-07	249.0	6490HA-249-07
129.0	6490HA-129-07	259.0	6490HA-259-07
139.0	6490HA-139-07	269.0	6490HA-269-07
149.0	6490HA-149-07	279.0	6490HA-279-07
159.0	6490HA-159-07	289.0	6490HA-289-07
169.0	6490HA-169-07	299.0	6490HA-299-07
179.0	6490HA-179-07	309.0	6490HA-309-07
189.0	6490HA-189-07	319.0	6490HA-319-07
199.0	6490HA-199-07	329.0	6490HA-329-07

**CENTERLIFT 6490**

- Black RAL 9005

- Incl. control button Mini in the motor units (left and right side)

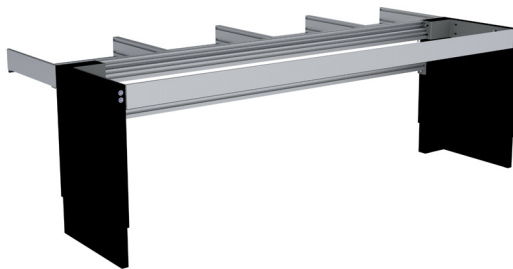

79.0	6490HA-079-10	209.0	6490HA-209-10
89.0	6490HA-089-10	219.0	6490HA-219-10
99.0	6490HA-099-10	229.0	6490HA-229-10
109.0	6490HA-109-10	239.0	6490HA-239-10
119.0	6490HA-119-10	249.0	6490HA-249-10
129.0	6490HA-129-10	259.0	6490HA-259-10
139.0	6490HA-139-10	269.0	6490HA-269-10
149.0	6490HA-149-10	279.0	6490HA-279-10
159.0	6490HA-159-10	289.0	6490HA-289-10
169.0	6490HA-169-10	299.0	6490HA-299-10
179.0	6490HA-179-10	309.0	6490HA-309-10
189.0	6490HA-189-10	319.0	6490HA-319-10
199.0	6490HA-199-10	329.0	6490HA-329-10

**Recommended accessories**

**Cabinet side**



**Cover package**



**Front that conceals the lifting frame**



**Hanging cabinets**

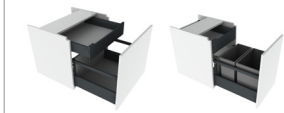

**Safety plates (under cabinets)**

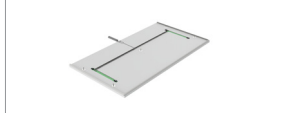

**Side with space for knees**

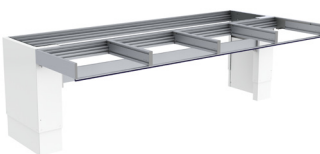

**Control button**



**Front**



**Box**

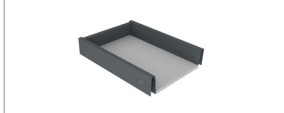

**Cover panel and hose cover**

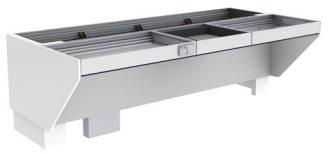
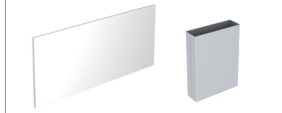



**Hanging cabinet with drawers**  
 The cabinet has a large drawer and a smaller inner drawer for cutlery and utensils.  
 Fully extendable with soft-close.  
 Frame height 510 mm  
 Frame depth: 470 mm  
 Frame in white melamine.  
 White-lacquered door (NCS 0500-N)

30.0 cm	760-030-01
40.0 cm	760-040-01
50.0 cm	760-050-01
60.0 cm	760-060-01
70.0 cm	760-070-01
80.0 cm	760-080-01

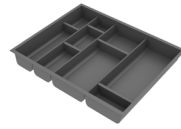

**Cutlery compartment for inner drawer**

Fits 30.0 cm wide inner drawer	460-030
Fits 40.0 cm wide inner drawer	460-040
Fits 50.0 cm wide inner drawer	460-050
Fits 60.0 cm wide inner drawer	460-060
Fits 70.0 cm wide inner drawer	460-070
Fits 80.0 cm wide inner drawer	460-080



**Cover package**  
 The package contains gable cover and gable front cover  
 White-lacquered 16 mm MDF (NCS 0500-N)

	61515-01
--	----------



**Hanging cabinet with waste sorting bins, 40 cm**  
 The cabinet is fitted with 2 waste bins. The upper part has an inner drawer for cutlery and utensils.  
 Fully extendable with soft-close.  
 Frame height 510 mm  
 Frame depth: 470 mm  
 Waste bins (litre):  
 1 pc 17 litre, 1 pc 11 litre  
 Frame in white melamine.  
 White-lacquered door (NCS 0500-N)

	761-040-01
--	------------

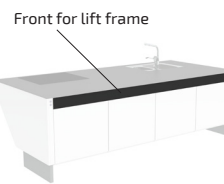

**Front that covers the lift frame**  
 Front covering the lift frame above the drawer fronts.  
 Total length:  
 Width of lift -94 mm  
 Replace xxx with cm when ordering.  
 Example, 385H-040-01 for 40.0 cm  
 Height: 103 mm  
 White-painted front in MDF, NCS 0500-N  
 Lacquered aluminium, white RAL 9003  
 Lacquered ALU, anthracite RAL 9004  
 Lacquered ALU, black RAL 9004  
 Anodised ALU

	380H-xxx-01
	385H-xxx-01
	385H-xxx-07
	385H-xxx-10
	385H-xxx-06

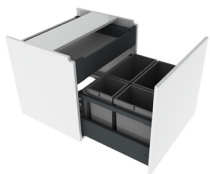

**Hanging cabinet with waste sorting bins, 60 cm**  
 The cabinet is fitted with 4 waste bins. The upper part has an inner drawer for cutlery and utensils.  
 Fully extendable with soft-close.  
 Frame height 510 mm  
 Frame depth: 470 mm  
 Waste bins (litre):  
 1 pc 17 litre, 1 pc 11 litre, 1 pc 8 litre, 1 pc 5 litre  
 Frame in white melamine.  
 White-lacquered door (NCS 0500-N)

	761-060-01
--	------------

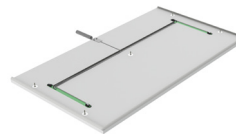

**Safety plates CENTERLIFT 6490**  
 The function of the safety plate is to stop the movement of the cabinet if the plate comes into contact with any object.  
 Mounted under the cabinets.  
 Colour: White  
 Thickness: 12 mm  
 Depth: 466 mm

30.0 cm width	6253-030-01
40.0 cm width	6253-040-01
50.0 cm width	6253-050-01
60.0 cm width	6253-060-01
70.0 cm width	6253-070-01
80.0 cm width	6253-080-01

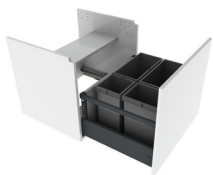

**Hanging cabinet under sink, 60 cm**  
 The cabinet is fitted with 4 waste bins.  
 Fully extendable with soft-close.  
 Frame height 510 mm  
 Frame depth: 470 mm  
 Waste bins (litre):  
 1 pc 17 litre, 1 pc 11 litre, 1 pc 8 litre, 1 pc 5 litre  
 Frame in white melamine.  
 White-lacquered door (NCS 0500-N)

	762-060-01
--	------------



**Safety package for safety plate of your own design**  
 The safety package contains micro-switches and cables for mounting on your own board. Instructions with milling dimensions enclosed.  
 The dimensions of the board must be:  
 Thickness: 12-16 mm  
 Width: 400 - 800 mm  
 Depth: 466 mm

	6253-00
--	---------



**Hanging cabinet under sink, 80 cm**  
 The cabinet is fitted with 6 waste bins.  
 Fully extendable with soft-close.  
 Frame height 510 mm  
 Frame depth: 470 mm  
 Waste bins (litre):  
 1 pc 17 litre, 1 pc 11 litre, 2 pcs 8 litre, 2 pcs 5 litre  
 Frame in white melamine.  
 White-lacquered door (NCS 0500-N)









	762-080-01
--	------------











**Fittings for hanging cabinet**  
 One set per cabinet.

	6250-001
--	----------



	<p><b>Control button in ALU-design</b> Wired, for recessed mounting Dimensions: 82 x 82 x 17 mm</p>	61320
	<p><b>Control button, Mini</b> Wired, for recessed mounting Diameter: 20 mm</p>	61318
	<p><b>Radio control - Hand control</b> Dimensions: 38 x 110 x 10 mm For one lift</p>	61385
	<p><b>Multi-compartment frame, ALU-design</b> Collects power socket, power switch or control buttons in a multi-compartment frame.</p>	<p>Two-compartment frame: 153 x 82 x 9 mm 61352</p> <p>Three-compartment frame: 225 x 82 x 9 mm 61353</p>
	<p><b>Socket, ALU-design</b> Earthed socket 230 V with flap cover. Dimensions: 82 x 82 x 17 mm Only Europe</p>	61330
	<p><b>Power switch, ALU-design</b> For lighting, for example. The button has a sign for desired marking. Dimensions: 82 x 82 x 17 mm</p>	61331
	<p><b>Safety lock</b> Prevents unauthorised use. Dimensions: 23 x 9 mm</p>	61360
	<p><b>Front for part with space for knees</b> Front that gives a neat look on the side with space for knees.</p> <p>Total length: Width of lift -94 mm</p> <p>Replace xxx with cm when ordering. Example, 385H-040-01 for 40.0 cm Also used for drawers. Optional length, 20.0 - 340.0 cm Height: 103 mm</p>	<p>Front in MDF, White NCS 0500-N 380H-xxx-01</p> <p>Lacquered Alu. white RAL 9003 385H-xxx-01</p> <p>Lacquered Alu. anthracite RAL 9004 385H-xxx-07</p> <p>Lacquered Alut. black RAL 9004 385H-xxx-10</p> <p>Anodised aluminium 385H-xxx-06</p>
	<p><b>Integrated drawer with full extension and soft-close or push-to-open function</b></p> <p>Depth: 470 mm, height: 85 mm Colour: Anthracite (RAL 9004)</p>	<p>30.0 cm 465H-030</p> <p>40.0 cm 465H-040</p> <p>50.0 cm 465H-050</p> <p>60.0 cm 465H-060</p> <p>80.0 cm 465H-080</p> <p>30.0 cm - Push-to-open function 466H-030</p> <p>40.0 cm - Push-to-open function 466H-040</p> <p>50.0 cm - Push-to-open function 466H-050</p> <p>60.0 cm - Push-to-open function 466H-060</p> <p>80.0 cm - Push-to-open function 466H-080</p>

	<p><b>Cutlery compartment</b></p>	<p>Fits 30.0 cm wide drawer 463-030</p> <p>Fits 40.0 cm wide drawer 463-040</p> <p>Fits 50.0 cm wide drawer 463-050</p> <p>Fits 60.0 cm wide drawer 463-060</p> <p>Fits 80.0 cm wide drawer 463-080</p>
	<p><b>Hob cover under worktop lift</b> Provides a smooth underside. Used under the hob. White-lacquered metal RAL 9003</p>	<p>60.0 cm 6266-060</p> <p>70.0 cm 6266-070</p> <p>80.0 cm 6266-080</p> <p>90.0 cm 6266-090</p> <p>100.0 cm 6266-100</p>
	<p><b>Cover panel</b> Used to cover installations under the worktop.</p> <p>12 mm white melamine 1 pc height 510 mm 2 pcs are required for lengths over 2490 mm</p>	6263-240-01
	<p><b>Fittings set for cover panels</b> Used to mount cover panels that conceal installations under the worktop.</p> <p>2 pcs are required for lengths over 2490 mm</p>	6263-001
	<p><b>Hose cover</b> Mounted under the worktop to provide a neat coverage of hoses.</p> <p>Anodised aluminium Fittings are included.</p> <p>Width: 300 mm, Depth: 85 mm</p>	61509-06
	<p><b>Height-adjustment kit</b> Used to change stroke after installation. Contains programming box and memory adapter.</p>	61400
	<p><b>Mini cabinet on wheels with drawer and inner drawer, fully extendable with soft-close</b></p> <p>The cabinet is opened by pulling out the drawer.</p> <p>Width: 400 mm, Height: 574 mm Depth incl. grip handle: 495 mm</p> <p>Top board in white compact laminate with integrated grip handle.</p> <p>Frame in white melamine. White-lacquered door (NCS 0500-N)</p>	770-040-01
	<p><b>Mini cabinet on wheels with waste sorting and inner drawer, fully extendable with soft-close</b></p> <p>The cabinet is opened by pulling out the drawer. The bottom with the waste bins is included.</p> <p>Included bins: 1 pc 11 litre 1 pc 17 litre</p> <p>Width: 400 mm, Height: 574 mm Depth incl. grip handle: 495 mm</p> <p>Top board in white compact laminate with integrated grip handle.</p> <p>Frame in white melamine. White-lacquered door (NCS 0500-N)</p>	771-040-01

# ERGOSTEEL

## Sinks and mixer taps

The sinks in the ERGOSTEEL series all have shallow sink bowls and are suitable for use in a sitting position.

Our mixer taps are suitable for shallow sink bowls and have a long ergonomic lever.



**Inset sinks**



Our inset sinks are either undermounted to the top board or inset from above. The inset sinks are manufactured in 0.8 mm, smooth stainless steel.



**Inset**

A hole is sawn in the worktop and the inset sink is put in position from above. The inset sink is then fastened underneath with fittings while the outer edge lies on top of the board. This method is suitable for all types of worktop materials except natural stone. The hole is made on the spot by a fitter.



**Undermounted**

A hole with an edge is milled out in the worktop from below. The inset sink is then glued on from underneath. The thickness of the visible material above the sink varies depending on whether this is done in laminate, wood or acrylic stone. Supplied assembled from the factory.



*The inset sinks are equipped with shallow sink bowls, adapted for sitting work.*



*The sink bowls are available in different sizes and combinations.*

**Sit-on sinks**



Our Sit-on sinks are made of 1.0 mm, smooth stainless steel sheet. There is a raised ledge around the entire sink to prevent water from flowing over the edge.

Sit-on sinks units are adapted to our height-adjustable bench systems and thus provide a 15 mm space on the wall side for splash protection.

The width of the sinks is 10 mm shorter than standard to provide a 5 mm gap on each side of the height-adjustable units to the adjacent cabinet or wall.



*All sinks are equipped with shallow sink bowls, adapted for sitting work.*

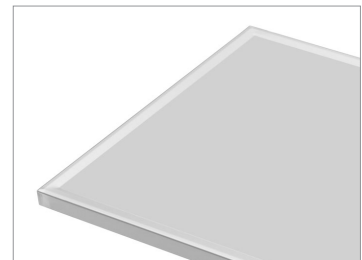

*The raised ledge effectively stops water from flowing over the edge.*

 Inset  Undermounted

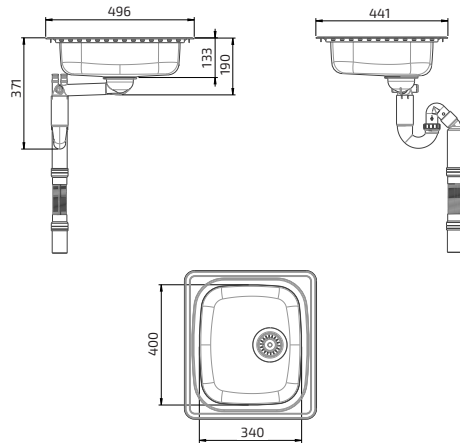

**Inset sink  
Granberg ES10 - 44.1 cm**

- For cabinet size: 400 mm
- Height of the sink bowls: 120 mm
- Outer dimensions: 441 x 496 mm
- Dimensions of sawn-out hole: 415 x 474 mm
- Plate thickness: 0.8 mm, brushed stainless steel
- Mounting: Inset or undermounted
- Incl. basket valve and water lock with flexible drain hose

618ES10-044

 Inset  Undermounted

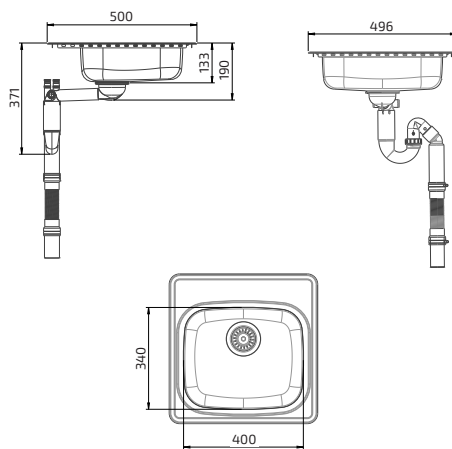

**Inset sink  
Granberg ES11 - 49.6 cm**

- For cabinet size: 500 mm
- Height of the sink bowls: 120 mm
- Outer dimensions: 500 x 496 mm
- Dimensions of sawn-out hole: 480 x 474 mm
- Plate thickness: 0.8 mm, brushed stainless steel
- Mounting: Inset or undermounted
- Incl. basket valve and water lock with flexible drain hose

618ES11-050

 Inset  Undermounted

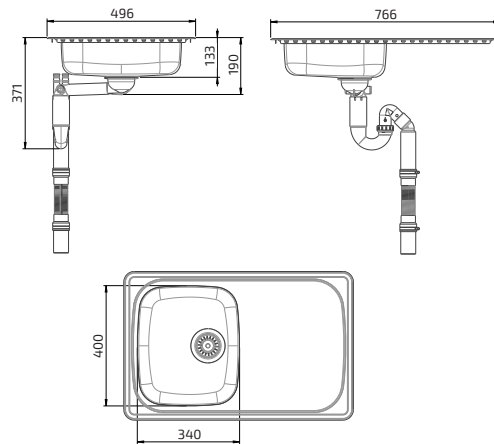

**Inset sink  
Granberg ES15 - 76.6 cm**

- For cabinet size: 400 mm
- Height of the sink bowls: 120 mm
- Outer dimensions: 766 x 496 mm
- Dimensions of sawn-out hole: 740 x 474 mm
- Plate thickness: 0.8 mm, brushed stainless steel
- Mounting: Inset or undermounted
- Incl. basket valve and water lock with flexible drain hose
- Reversible, for right or left

618ES15-077

 Inset  Undermounted

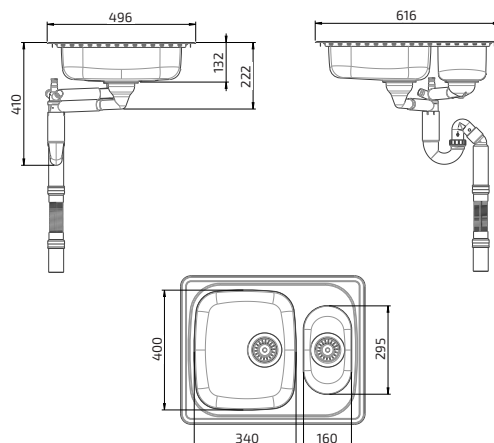

**Inset sink  
Granberg ES20 - 61.6 cm**

- For cabinet size: 600 mm
- Height of the sink bowls: 120 mm
- Outer dimensions: 616 x 496 mm
- Dimensions of sawn-out hole: 590 x 474 mm
- Plate thickness: 0.8 mm, brushed stainless steel
- For inset fitting or undermounting
- Incl. basket valve and water lock with flexible drain hose
- Reversible, for right or left

618ES20-062



Inset



Undermounted



**Inset sink  
Granberg ES25 - 97.1 cm**

- For cabinet size: 600 mm
- Height of the sink bowls: 120 mm
- Outer dimensions: 971 x 496 mm
- Dimension of sawn-out hole: 945 x 474 mm
- Plate thickness: 0.8 mm, brushed stainless steel
- Mounting: Inset or undermounted
- Incl. basket valve and water lock with flexible drain hose
- Reversible, for right or left

618ES25-097

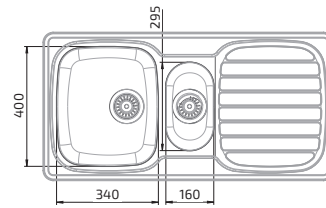
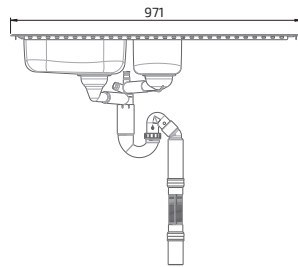
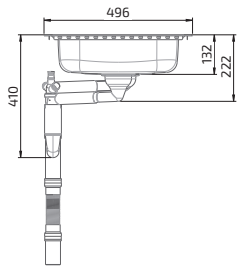

Inset



Undermounted



**Inset sink  
Granberg ES30 - 76.6 cm**

- For cabinet size: 800 mm
- Height of the sink bowls: 120 mm
- Outer dimensions: 766 x 496 mm
- Dimension of sawn-out hole: 740 x 474 mm
- Plate thickness: 0.8 mm, brushed stainless steel
- Mounting: Inset or undermounted
- Incl. basket valve and water lock with flexible drain hose
- Reversible, for right or left

618ES30-077

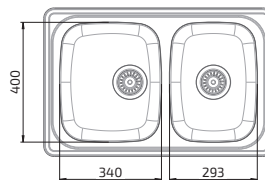
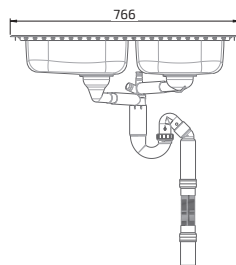
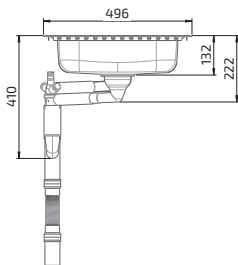

Inset



Undermounted



**Inset sink  
Granberg ES35 - 120.6 cm**

- For cabinet size: 800 mm
- Height of the sink bowls: 120 mm
- Outer dimensions: 1206 x 496 mm
- Dimensions of sawn-out hole: 1180 x 474 mm
- Plate thickness: 0.8 mm, brushed stainless steel
- Mounting: Inset or undermounted
- Incl. basket valve and water lock with flexible drain hose
- Reversible, for right or left

618ES35-121

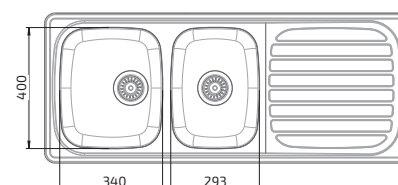
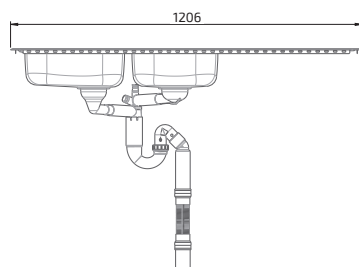
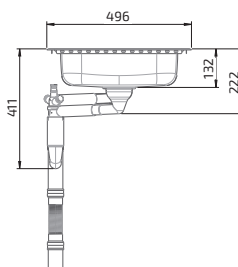

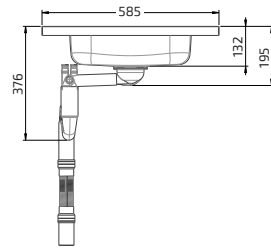

**Sit-on sink with 1 sink bowl  
Granberg ESF**

- For cabinet size: 400 mm
- Height of the sink bowl: 120 mm
- Depth: 585 mm\*
- Edge height: 30 mm
- Plate thickness: 1 mm smooth stainless steel plate on an underside of fully-glued MDF board
- Incl. basket valve and water lock with flexible drain hose
- Reversible, for right or left

\* Adapted to our height-adjustable bench systems and thus provide a 15-mm space on the wall side for splash protection.

The width of our sinks is 10 mm shorter than standard to provide a 5-mm gap on each side of the height-adjustable units to the adjacent cabinet or wall.

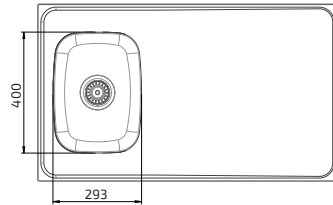
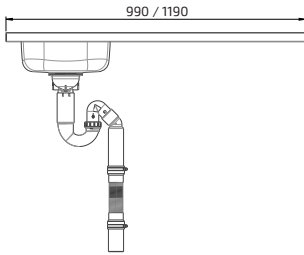

Sit-on sink with 1 sink bowl, 99 cm - Granberg ESF	617ESF-099
--	------------

Sit-on sink with 1 sink bowl, 119 cm - Granberg ESF	617ESF-119
---	------------

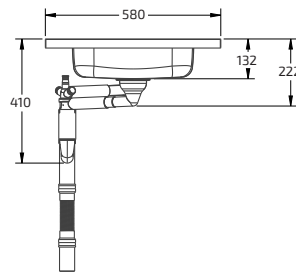

**Sit-on sink with 2 sink bowls  
Granberg ESG**

- For cabinet size: 600 mm
- Height of the sink bowls: 120 mm
- Depth: 585 mm\*
- Edge height: 30 mm
- Plate thickness: 1 mm smooth stainless steel plate on an underside of fully-glued MDF board
- Incl. basket valve and water lock with flexible drain hose
- Reversible, for right or left

\* Adapted to our height-adjustable bench systems and thus provide a 15-mm space on the wall side for splash protection.

The width of our sinks is 10 mm shorter than standard to provide a 5-mm gap on each side of the height-adjustable units to the adjacent cabinet or wall.

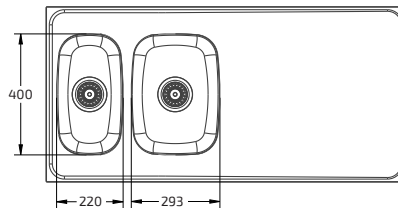
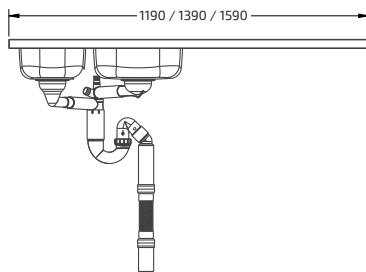

Sit-on sink with 2 sink bowls, 119 cm - Granberg ESG	617ESG-119
--	------------

Sit-on sink with 2 sink bowls, 139 cm - Granberg ESG	617ESG-139
--	------------

Sit-on sink with 2 sink bowls, 159 cm - Granberg ESG	617ESG-159
--	------------

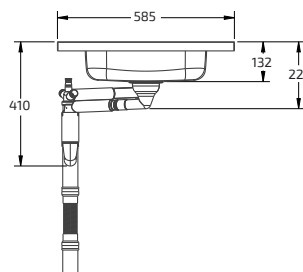

**Sit-on sink with 2 sink bowls  
Granberg ESH**

- For cabinet size: 800 mm
- Height of the sink bowls: 120 mm
- Depth: 585 mm\*
- Edge height: 30 mm
- Plate thickness: 1 mm smooth stainless steel plate on an underside of fully-glued MDF board
- Incl. basket valve and water lock with flexible drain hose
- Reversible, for right or left

\* Adapted to our height-adjustable bench systems and thus provide a 15-mm space on the wall side for splash protection.

The width of our sinks is 10 mm shorter than standard to provide a 5-mm gap on each side of the height-adjustable units to the adjacent cabinet or wall.

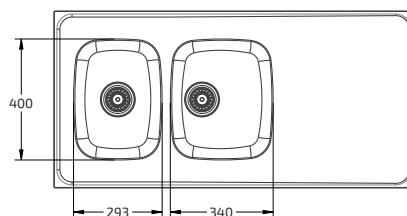
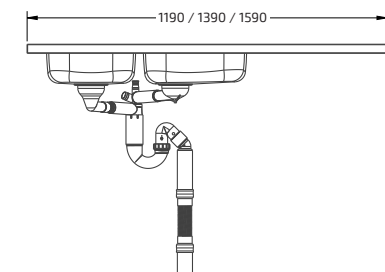

Sit-on sink with 2 sink bowls, 119 cm - Granberg ESH	617ESH-119
--	------------

Sit-on sink with 2 sink bowls, 139 cm - Granberg ESH	617ESH-139
--	------------

Sit-on sink with 2 sink bowls, 159 cm - Granberg ESH	617ESH-159
--	------------



Hob not included

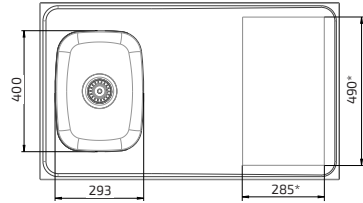
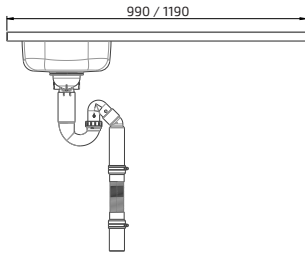
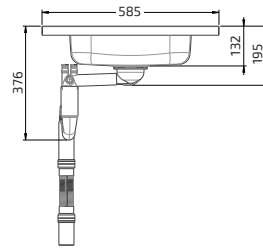

\* Can be customised

**Sit-on sink with 1 sink bowl and hole for hob  
Granberg ESFS**

- For cabinet size: 400 mm
- Height of the sink bowl: 120 mm
- Depth: 585 mm\*
- Edge height: 30 mm
- Plate thickness: 1 mm smooth stainless steel plate on an underside of fully-glued MDF board
- Incl. basket valve and water lock with flexible drain hose
- Reversible, for right or left

\* Adapted to our height-adjustable bench systems and thus provide a 15-mm space on the wall side for splash protection.

The width of our sinks is 10 mm shorter than standard to provide a 5-mm gap on each side of the height-adjustable units to the adjacent cabinet or wall.

Sit-on sink with 1 sink bowl and hole for hob 99 cm - Granberg ESFS	617ESFS-099
Sit-on sink with 1 sink bowl and hole for hob 119 cm - Granberg ESFS	617ESFS-119

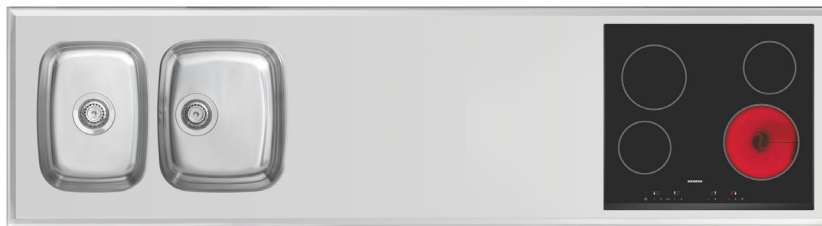

Hob not included

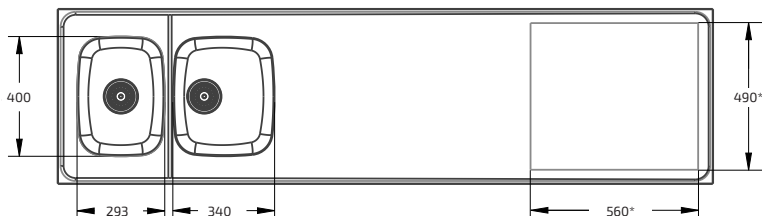
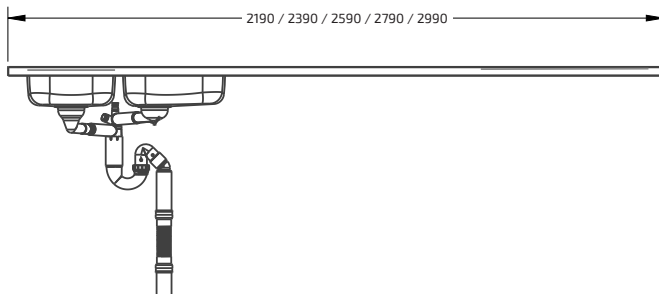
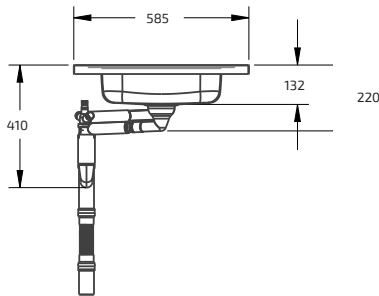

\* Can be customised

**Sit-on sink - 2 sink bowls and hole for hob  
Granberg ESHS**

- For cabinet size: 800 mm
- Height of the sink bowls: 120 mm
- Depth: 585 mm\*
- Edge height: 30 mm
- Plate thickness: 1 mm smooth stainless steel plate on an underside of fully-glued MDF board
- Incl. basket valve and water lock with flexible drain hose
- Reversible, for right or left

\* Adapted to our height-adjustable bench systems and thus provide a 15-mm space on the wall side for splash protection.

The width of our sinks is 10 mm shorter than standard to provide a 5-mm gap on each side of the height-adjustable units to the adjacent cabinet or wall.

Sit-on sink with 2 sink bowls and hole for hob 219 cm - Granberg ESHS	617ESHs-219
Sit-on sink with 2 sink bowls and hole for hob 239 cm - Granberg ESHS	617ESHs-239
Sit-on sink with 2 sink bowls and hole for hob 259 cm - Granberg ESHS	617ESHs-259
Sit-on sink with 2 sink bowls and hole for hob 279 cm - Granberg ESHS	617ESHs-279
Sit-on sink with 2 sink bowls and hole for hob 289 cm - Granberg ESHS	617ESHs-289



**Chopping board for sink bowl 293x400 mm**

Chopping board placed over sink bowl to provide food preparation surface/cutting board.

Suitable for sink bowls sized 293x400 mm.

Made from cultivated teak

618-025



**Chopping board for sink bowl 340x400 mm**

Chopping board placed over sink bowl to provide food preparation surface/cutting board.

Fits sink bowls sized 340x400 mm.

Made from cultivated teak

618-026



**Wire basket for sink bowl 340x400 mm**

Wire basket that can be used as a drainer. Fits sink bowls sized 340x400 mm.

Made of white plastic-coated wire.

618-024



**Cutlery box for rinsing bowl 160x295 mm**

Cutlery box that fits rinsing bowl sized 160x295 mm.

Made from white plastic.

618-023





**Rinsing bowl for sink bowl 160x295 mm**

Rinsing bowl that fits sink bowls sized 160x295 mm.

Made from white plastic.

618-027



**Washing-up liquid dispenser**

Pump for washing-up liquid.

Requires hole to be made in sink.

618-022



**Strainer package for sinks**

The package contains:

- 1 rubber plug
- 2 strainers
- 2 spacers

618-020



**Rotary valve for sinks**

With a rotary valve, the drain is closed with a lever that is recessed into the sink.

Requires hole to be made in sink.

618-021

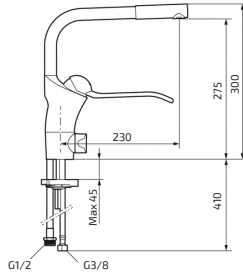

**Granberg's mixer tap**

Incl. dishwasher closure  
Length of lever, 190 mm  
Height of spout, 300 mm

60210

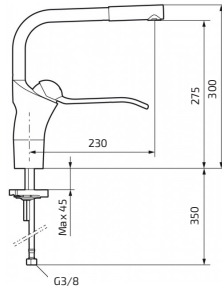

**Granberg's mixer tap**

Excl. dishwasher closer  
Length of lever, 190 mm  
Height of spout, 300 mm

60211



**Flexible water hoses 2-pack**

In combination with the worktop lift, water hoses provide flexible water connection.

Length, 500 mm, connection R15 (1/2")

61800



**Flexible drain hose**

In combination with the worktop lift, drain hoses provide flexible drain connection.

*The hose is included with our sinks.*

Drain hose:  
Length, 200 - 650 mm  
Diameter at connection, 50 mm

61801

## Mini-cabinet on wheels



Integrated grip handle makes it easy to move the mini cabinet on wheels if necessary. Choose between waste sorting or saucepan storage. Both models have a large drawer that is pulled out to access the contents. Underneath the drawer, there is a support wheel that prevents the cabinet from tipping forward.



### Mini cabinet on wheels with drawer and inner drawer, fully extendable with soft-close

The cabinet is opened by pulling out the drawer.

Width: 400 mm  
Height: 574 mm  
Depth incl. grip handle: 495 mm

Top board in white compact laminate with integrated grip handle.

Frame in white melamine.  
White-lacquered door (NCS 0500-N)

770-040-01

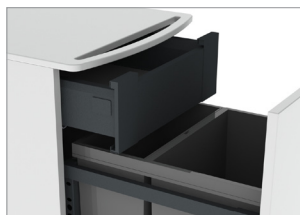

### Mini cabinet on wheels with waste sorting and inner drawer, fully extendable with soft-close

The cabinet is opened by pulling out the drawer.  
The bottom with the waste bins is included.

Included bins:  
1 pc 11 litre 1 pc 17 litre

Width: 400 mm  
Height: 574 mm  
Depth incl. grip handle: 495 mm

Top board in white compact laminate with integrated grip handle.

Frame in white melamine.  
White-lacquered door (NCS 0500-N)

771-040-01

# UNILIFT 870

Kitchen appliance lift

UNILIFT raises a board upwards and outwards from the bottom of a cabinet or tall cabinet. A kitchen appliance, microwave oven or other household machinery can be placed on the board.

With a simple press of a button, the height of the board is adjusted to optimal working height.



## Functions and advantages

- Raises heavy household appliances to a comfortable height
- The movement can be stopped at any height.
- Easily mounted on the bottom of a cabinet or tall cabinet.
- Can be mounted in new or existing cabinets

## Standard equipment

- Wired hand control
- Work surface board

## Specifications

<b>Mounting</b>	In a bench cabinet or high cabinet
<b>Height adjustment</b>	Motorised, steplessly adjustable 745 mm upwards and 500 mm outwards from the cabinet
<b>Speed</b>	37 mm / sec.
<b>Manoeuvring</b>	Wired hand control or radio control
<b>Electricity connection</b>	Plug for 230 V, Max 2.5 A
<b>Maximum load on board</b>	20 kg
<b>Fits cabinets with width</b>	400 - 600 mm
<b>Material specifications</b>	Powder-lacquered sheet metal parts (alu-grey RAL 9006)
<b>Guarantee</b>	2 years
	CE

## Measurement data

(mm)

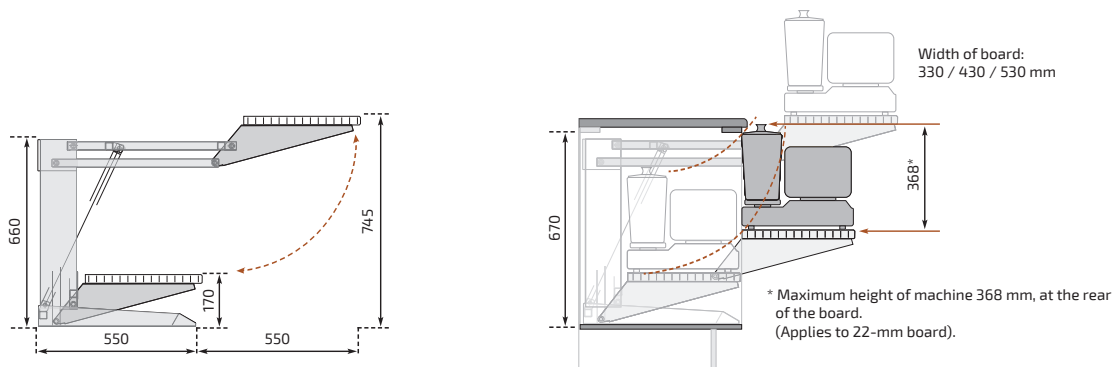



**UNILIFT 870**

Supplied with wired hand control and white melamine worktop with edging in ABS plastic, thickness 22 mm.

For cabinet width: 40.0 cm Dimensions of board: W x D: 33.0 x 35.0 cm	870-04063
For cabinet width: 50.0 cm Dimensions of board: W x D: 43.0 x 35.0 cm	870-05063
For cabinet width: 60.0 cm Dimensions of board: W x D: 53.0 x 35.0 cm	870-06063



**UNILIFT 870 - Lifting unit**

Width of lift: 340 mm

	870-034
--	---------

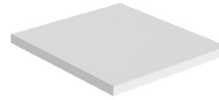

**Worktop**

The board is made of white laminate with edging of ABS plastic.

Depth: 350 mm  
Thickness: 22 mm

Width: 33.0 cm (For cabinet width 40.0 cm)	891-033
Width: 43.0 cm (For cabinet width 50.0 cm)	891-043
Width: 43.0 cm (For cabinet width 50.0 cm)	891-053



**Radio control - Hand control**

Dimensions: 38 x 110 x 10 mm

For one lift	61385
--------------	-------



**Hand control**

Wired hand control.  
Hanging fittings included.  
Dimensions: 147 x 56 x 23 mm

	61305
--	-------

# BUTLER 720

Electric wardrobe lift

The top part of a wardrobe is inaccessible for a person in a wheelchair but with the help of BUTLER 720, the clothes can be lowered to a comfortable position by simply pressing a button.

Wire crates can be placed in the lower part which provides efficient storage that is accessible for everyone.

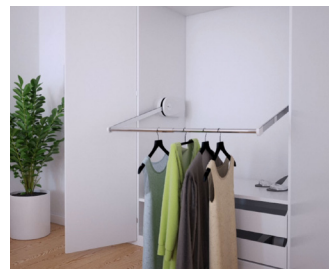

## Functions and advantages

- Motorised clothes rod, adjustable 70.4 cm downwards
- Maximum load 30 kg
- Telescopic clothes rod for cabinet with inner dimensions 54.5 to 156.8 cm
- Modern and discreet design
- Collision protection stops the lowering of the wardrobe rail if it comes into contact with any object
- Silent motors that take up little space

## Specifications

<b>Type of lift</b>	Electric wardrobe lift that lowers the clothes rod in front of the wardrobe
<b>Adjustability</b>	Motorised clothes rod, steplessly adjustable 704 mm downwards, 614 mm outwards
<b>Speed</b>	47 mm/sec.
<b>Manoeuvring</b>	Remote control or wired manoeuvre device
<b>Electricity connection</b>	Plug for 100-240VAC, 50/60hz, 2.0 A
<b>Maximum load on clothes rod</b>	30 kg
<b>Fits cabinets with width</b>	600-900 mm / 1000-1600 mm
<b>Materials</b>	Chromed steel parts, plastic cover
<b>Noise level</b>	52 dB
<b>Warranty</b>	2 year
	CE

## Measurement data

(mm)

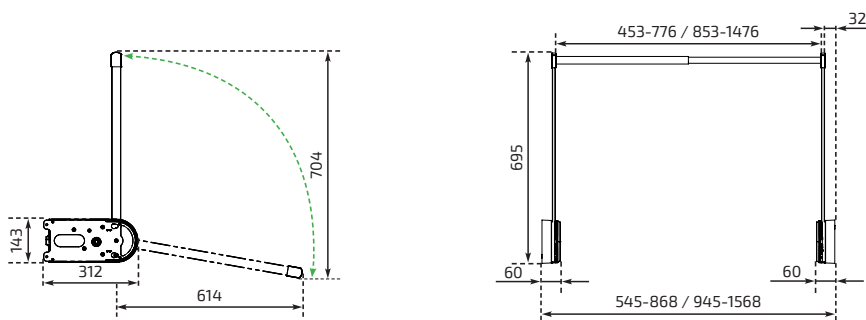

**Butler 720-White**

-Cover of white plastic RAL 9003, chromed steel parts



Cabinet width (cm)	Remote control, wireless	Hand control, wired	Aluminium button, wired
60.0 - 90.0	720-060-0201	720-060-0301	720-060-0101
100.0 - 160.0	720-100-0201	720-100-0301	720-100-0101

**Butler 720-Grey**

- Cover of grey plastic RAL 7035, chromed steel parts



Cabinet width (cm)	Remote control, wireless	Hand control, wired	Aluminium button, wired
60.0 - 90.0	720-060-0206	720-060-0306	720-060-0106
100.0 - 160.0	720-100-0206	720-100-0306	720-100-0106

**Butler 720-Black**

- Cover of black plastic RAL 9005, chromed steel parts



Cabinet width (cm)	Remote control, wireless	Hand control, wired	Aluminium button, wired
60.0 - 90.0	720-060-0210	720-060-0310	720-060-0110
100.0 - 160.0	720-100-0210	720-100-0310	720-100-0110

# BUTLER 722

Electric wardrobe lift



With BUTLER 722, the height of the wardrobe can be used to the full. A simple push of a button lowers the clothes rod by 112 cm.

A person of normal height can easily reach up to 190 cm which means the clothes rod in its upper position can be 300 cm above the floor.

Thus, the lower part of the wardrobe can be used for another clothes rod or other form of storage.



## Functions and advantages

- Motorised adjustable clothes rod, 111.8 cm downwards
- Maximum load 30 kg
- Telescopic clothes rod for cabinet with inner dimensions 54.5 to 156.8 cm
- Modern and discreet design
- Collision protection stops the lowering of the wardrobe rail if it comes into contact with any object
- Silent motors that take up little space

## Specifications

<b>Type of lift</b>	Electric wardrobe lift that lowers the clothes rod in front of the wardrobe
<b>Adjustability</b>	Motorised clothes rod, steplessly adjustable 1118 mm downwards, 626 mm outwards
<b>Speed</b>	47 mm/sec.
<b>Manoeuvring</b>	Remote control or wired manoeuvre device
<b>Electricity connection</b>	Plug for 100-240VAC, 50/60hz, 2.0 A
<b>Maximum load on clothes rod</b>	30 kg
<b>Fits cabinets with width</b>	600-900 mm/1000-1600 mm
<b>Materials</b>	Powder-lacquered steel parts, plastic cover, chromed clothes rod
<b>Noise level</b>	52 dB
<b>Warranty</b>	2 year
	CE

## Measurement data

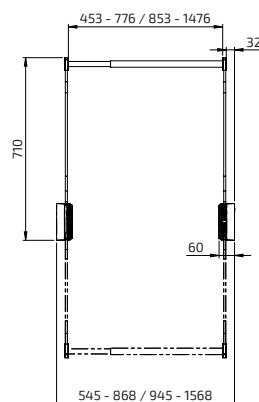
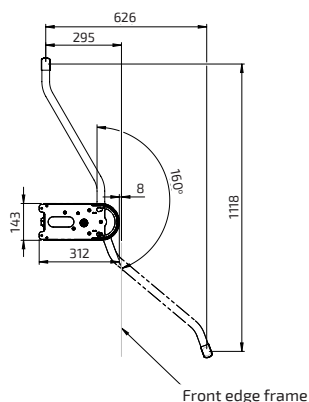

(mm)



**Butler 722-White**  
 - Cover of white plastic RAL 9003, powder-lacquered arms RAL 9003, chromed clothes rod



Cabinet width (cm)	Remote control, wireless	Hand control, wired	Aluminium button, wired
60.0 - 90.0	722-060-0201	722-060-0301	722-060-0101
100.0 - 160.0	722-100-0201	722-100-0301	722-100-0101

**Butler 722-Grey**  
 - Cover of grey plastic RAL 7035, powder-lacquered arms RAL 7035, chromed clothes rod



Cabinet width (cm)	Remote control, wireless	Hand control, wired	Aluminium button, wired
60.0 - 90.0	722-060-0206	722-060-0306	722-060-0106
100.0 - 160.0	722-100-0206	722-100-0306	722-100-0106

**Butler 722-Black**  
 -Cover of black plastic RAL 9005, powder-lacquered arms RAL 9005, chromed clothes rod



Cabinet width (cm)	Remote control, wireless	Hand control, wired	Aluminium button, wired
60.0 - 90.0	722-060-0210	722-060-0310	722-060-0110
100.0 - 160.0	722-100-0210	722-100-0310	722-100-0110

# Contact

Granberg Interior AB

Box 6112, SE-600 06 Norrköping, SWEDEN

Street address: Importgatan 30, SE-602 28 Norrköping, SWEDEN

Telephone: +46(0)11-19 77 50

Email: [info@granberg.se](mailto:info@granberg.se)

Internet: [www.granberg.se](http://www.granberg.se)





---

**GRANBERG INTERIOR AB**  
Box 6112  
600 06 Norrköping  
Sweden  
Tel: +46(0)11-19 77 50  
Email: [info@granberg.se](mailto:info@granberg.se)  
Internet: [www.granberg.se](http://www.granberg.se)

SINCE 1870

